

Patterns for Montana 4-H Horse Shows

This book of patterns, provided by the Montana State 4-H Horse Committee, has been made possible through the generous support of HorseShowPatterns.com, a company that has designed and customized over 1,000 patterns for judges, show managers and contestants worldwide. All patterns herein have been selected and customized by the State 4-H Horse Committee to comply with Montana 4-H assessment level requirements.

The patterns in this book are to be used solely and exclusively for Montana 4-H horse shows and for clinics sponsored by Montana 4-H. Patterns for uses other than Montana 4-H are available by subscription through HorseShowPatterns.com.

Tips for pattern users:

- These patterns are presented as ideas and options to consider for county and state 4-H horse shows in Montana. Use of these patterns is not required.
- Always check the pattern against the project assessment checklist found in horse project books to make sure it meets your expectations. The State 4-H Horse committee's goal was to develop patterns that meet and do not exceed assessment requirements for individual levels.
- Some of the 90 degree, 180 degree, 360 degree, etc. turns are not designated as hindquarter or forehand turns, so show management can designate what kind of turn they would like to be executed in the pattern or use the patterns as is and leave the decision up to the contestant or judge to choose.
- Unless otherwise indicated, lead changes are simple lead changes. Horsemanship Level 6, Colt to Maturity 5-Year-Olds, and Green Horse Level 4 can do flying lead changes.
- English Horsemanship riders Level 3 and up should ride the trot on the correct diagonal.
- In Hunter Hack patterns, only senior level exhibitors should hand gallop.
- There are pattern options for Colt to Maturity 2-Year-Olds and Green Horse Level 1, but show management may opt to just do rail work for this level.
- There are not specific patterns for English Colt to Maturity and Green Horse, but the existing Western patterns may be adapted to become English patterns with a change in terminology (change jog to trot, stop to halt, lope to canter, etc.).
- Ranch Horse patterns can be found in the Ranch Horse curriculum.

Thank you to the State 4-H Horse Committee for reviewing patterns and to Dr. David Denniston of HorseShowPatterns.com and his support of Montana 4-H that allows the Horse Committee to create a reference with his patterns for our state program!

Montana State 4-H Horse Patterns

English Horsemanship (Level 1)

Show Date:

w w w . H o r s e S h o w P a t t e r n s . c o m

w w w . H o r s e S h o w P a t t e r n s . c o m

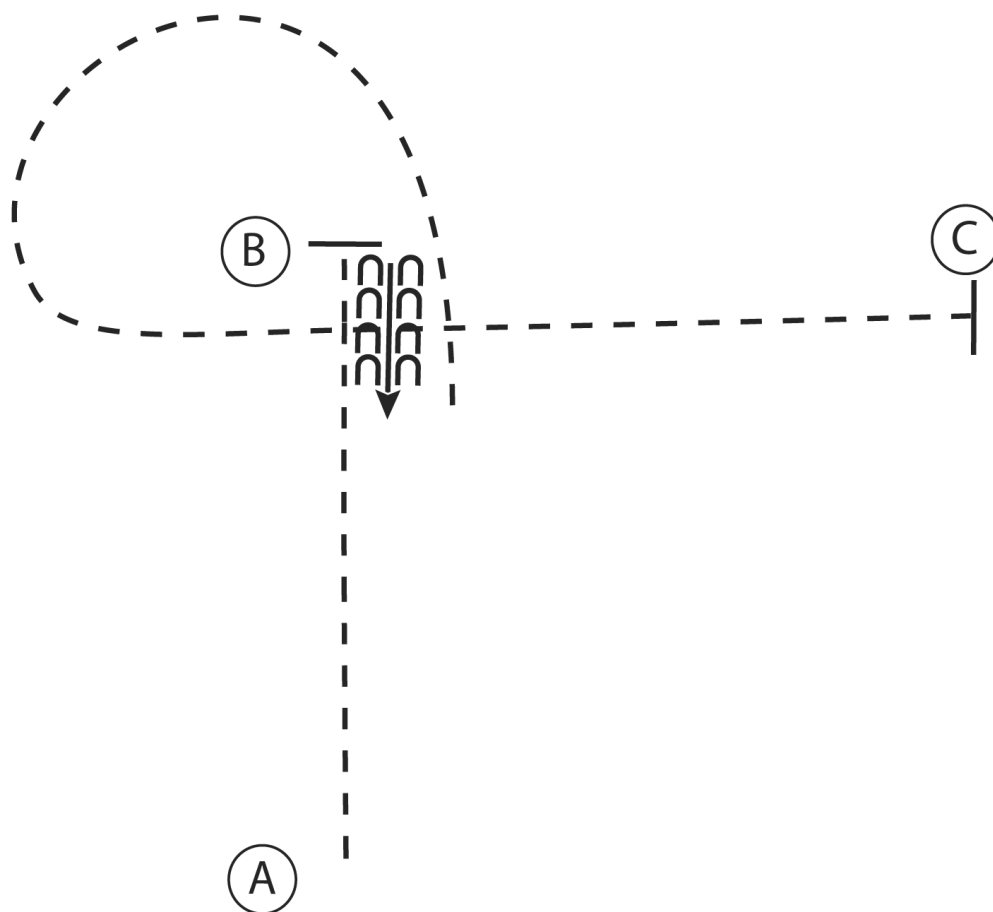

1. Trot A to B
2. At B stop and back 4 steps
3. Trot a circle around B and continue to C
4. Stop at C

Walk
Trot	- - - - -
Extended Trot	- - - - -
Canter	—————
Leg Yield	
Lead Change	↘
Back	←←←←←
Marker	(B)
Sidepass	←- - - - -

[HSE/WT-2]

Pattern Provided by:

Montana 4-H State Horse Committee

Montana State 4-H Horse Patterns

English Horsemanship (Level 1)

Show Date:

www.HorseShowPatterns.com

www.HorseShowPatterns.com

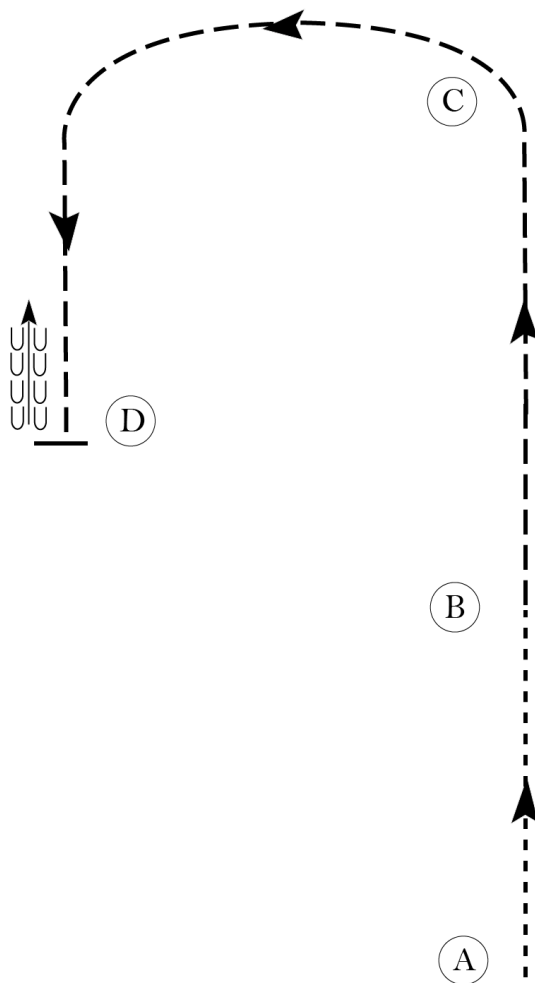

Be ready at A.

1. Walk from A to B.
2. Trot from B around C and to D.
3. Stop and back approximately one horse length at D.

Exit at a trot.

Walk	-----
Trot	- - - - -
Extended Trot	— — — — —
Canter	—————
Leg Yield	
Lead Change	— / —
Back	← ← ← ← ←
Marker	(B)
Sidepass	← — — — — ←
Hand Gallop	— — — — —

[2015HSE/HSE%20wt-22]

Pattern Provided by:

Montana 4-H State Horse Committee

Montana State 4-H Horse Patterns

English Horsemanship (Level 1)

Show Date:

www.HorseShowPatterns.com

www.HorseShowPatterns.com

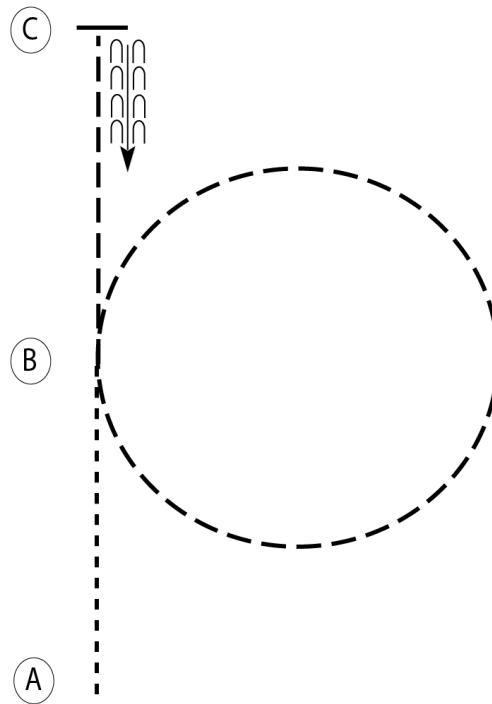

Be ready at A.

1. Walk from A to B.
2. At B, perform a trot circle to the right.
3. Return to B and trot to C.
4. Stop at C and back approximately one horse length.

Follow the instructions of your ring steward.

Walk	-----
Trot	- - - - -
Extended Trot	-----
Canter	—————
Leg Yield	
Lead Change	↙ ↘
Back	← ← ← ← ←
Marker	Ⓚ
Sidepass	← ← ← ← ←
Hand Gallop	—————

[HSE/wt-32a]

Pattern Provided by:

Montana 4-H State Horse Committee

Montana State 4-H Horse Patterns

English Horsemanship (Level 1)

Show Date:

w w w . H o r s e S h o w P a t t e r n s . c o m

w w w . H o r s e S h o w P a t t e r n s . c o m

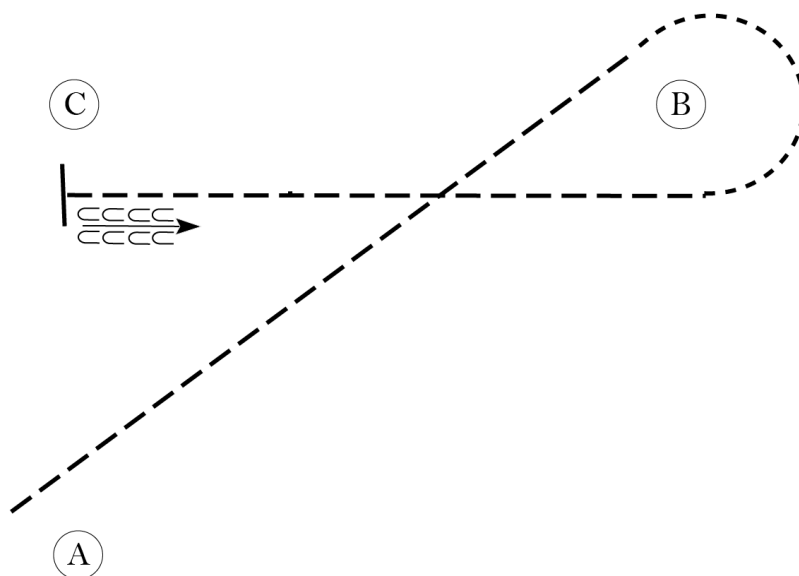

Be ready at A.

1. Trot from A to B.
2. Walk around B.
3. Trot to C.
4. Stop at C. Back approximately one horse length.

Follow the instructions of your ring steward.

Walk
Trot	-----
Extended Trot	-----
Canter	—————
Leg Yield	
Lead Change	////
Back	←←←
Marker	ⓑ
Sidepass	←→
Hand Gallop	———

[HSE/wt-26b]

Pattern Provided by:

Montana 4-H State Horse Committee

Montana State 4-H Horse Patterns

English Horsemanship (Level 1)

Show Date:

www.HorseShowPatterns.com

www.HorseShowPatterns.com

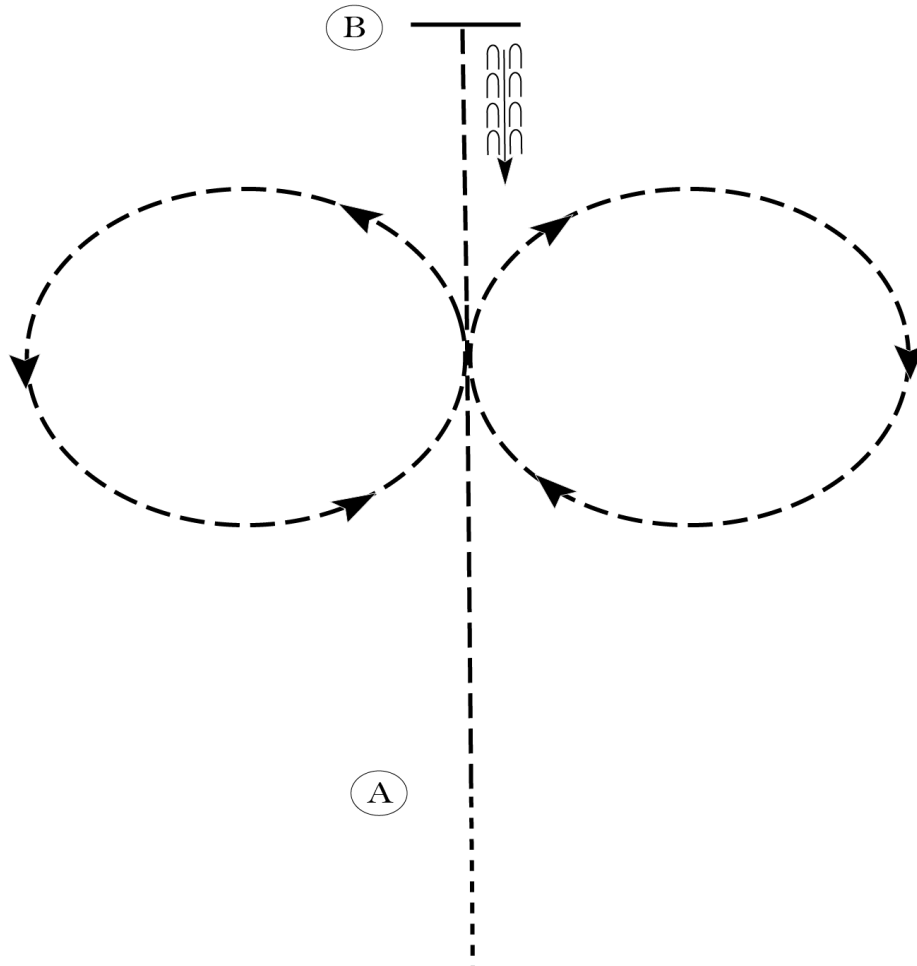

1. Walk to A.
2. At A trot towards B.
3. When halfway to B trot circle to the right followed by a trot circle to the left.
4. Continue the trot to B.
5. At B stop and back approximately one horse length.

Walk	-----
Trot	- - - - -
Extended Trot	— — — —
Canter	—————
Leg Yield	
Lead Change	— / —
Back	← ← ← ← ←
Marker	Ⓚ
Sidepass	← — — — ←
Hand Gallop	— — — —

[HSE/wt-4]

Pattern Provided by:

Montana 4-H State Horse Committee

Montana State 4-H Horse Patterns

English Horsemanship (Level 1)

Show Date:

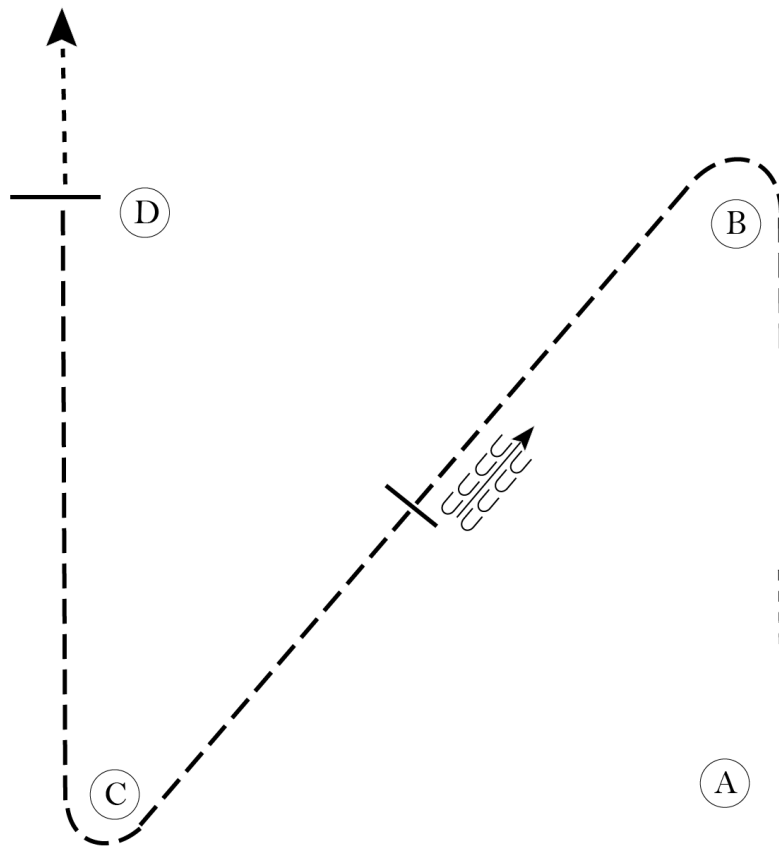

Be ready at A.

1. Walk approximately two horse lengths from A.
2. Trot to B.
3. At B, trot around B to middle.
4. Stop at middle and back one horse length.
5. Trot to C.
6. At C, trot around C to D.
7. Stop at D.
8. Exit at a walk.

Follow the directions of your ring steward.

Walk	-----
Trot	-----
Extended Trot	-----
Canter	-----
Lead Change	
Back	
Marker	
Hand Gallop	-----

[2015HSE/HSE%20wt-48]

Pattern Provided by:

Montana 4-H State Horse Committee

www.HorseShowPatterns.com

www.HorseShowPatterns.com

Montana State 4-H Horse Patterns

English Horsemanship (Level 2)

Show Date:

w w w . H o r s e S h o w P a t t e r n s . c o m

w w w . H o r s e S h o w P a t t e r n s . c o m

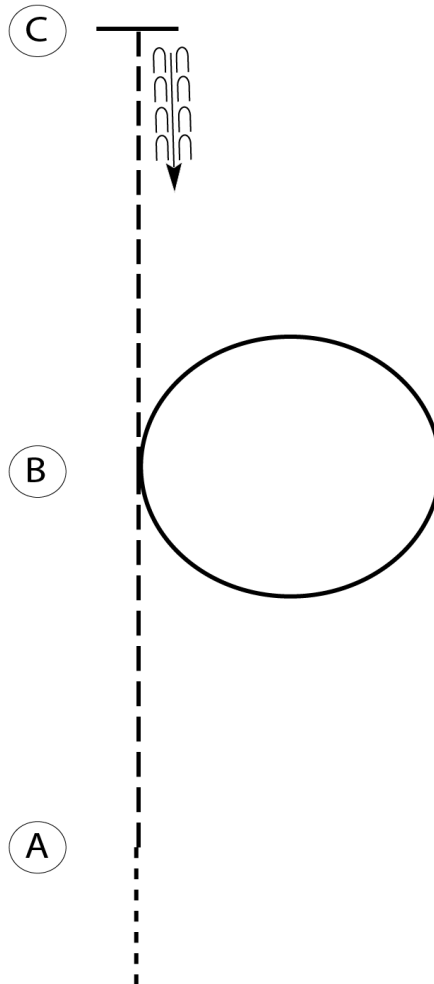

Be ready before A.

1. Walk to A.
2. Sitting trot from A to B.
3. At B, canter a circle to the right.
4. At B, posting trot to C.
5. Stop at C and back approximately one horse length.

Follow the instructions of your ring steward.

Walk	-----
Trot	- - - - -
Extended Trot	-----
Canter	—————
Leg Yield	
Lead Change	↙ ↘
Back	← ← ← ← ←
Marker	⊙
Sidepass	← — — — — →
Hand Gallop	—————

[2015HSE/HSE%201-32]

Pattern Provided by:

Montana 4-H State Horse Committee

Montana State 4-H Horse Patterns

English Horsemanship (Level 2)

Show Date:

www.HorseShowPatterns.com

www.HorseShowPatterns.com

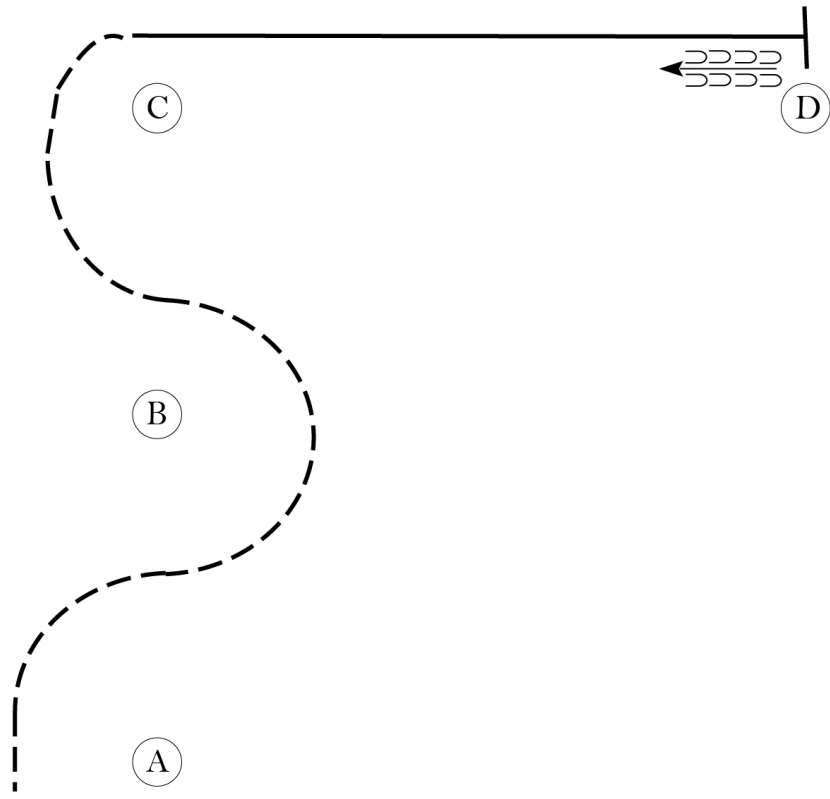

1. Starting to the left of A, posting trot to right side of B then to left side of C.
2. At C, canter to D.
3. Stop at D.
4. Back one horse length.

Walk	-----
Trot	- - - - -
Extended Trot	— — — — —
Canter	—————
Leg Yield	
Lead Change	↘
Back	←←←
Marker	Ⓚ
Sidepass	←- - - ->
Hand Gallop	— — — — —

[2015HSE/HSE%201-9]

Pattern Provided by:

Montana 4-H State Horse Committee

Montana State 4-H Horse Patterns

English Horsemanship (Level 2)

Show Date:

www.HorseShowPatterns.com

www.HorseShowPatterns.com

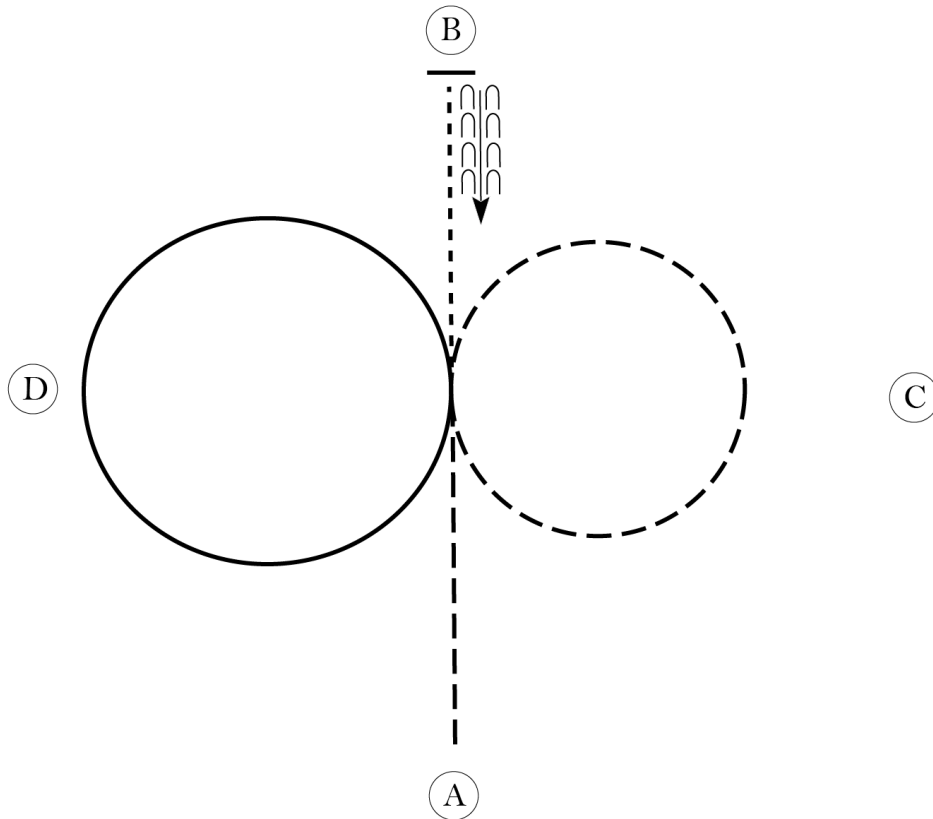

Be ready with your horse's tail to A.

1. Sitting trot halfway to B.
2. Rising trot circle to right.
3. Canter a circle to the left.
4. Walk to B.
5. Stop in front of B and back approximately one horse length.

Follow the directions of your ring steward.

Walk	-----
Trot	- - - - -
Extended Trot	— — — —
Canter	—————
Lead Change	
Back	
Marker	(B)
Hand Gallop	—————

[2015HSE/HSE%201-45]

Pattern Provided by:

Montana 4-H State Horse Committee

Montana State 4-H Horse Patterns

English Horsemanship (Level 2)

Show Date:

w w w . H o r s e S h o w P a t t e r n s . c o m

w w w . H o r s e S h o w P a t t e r n s . c o m

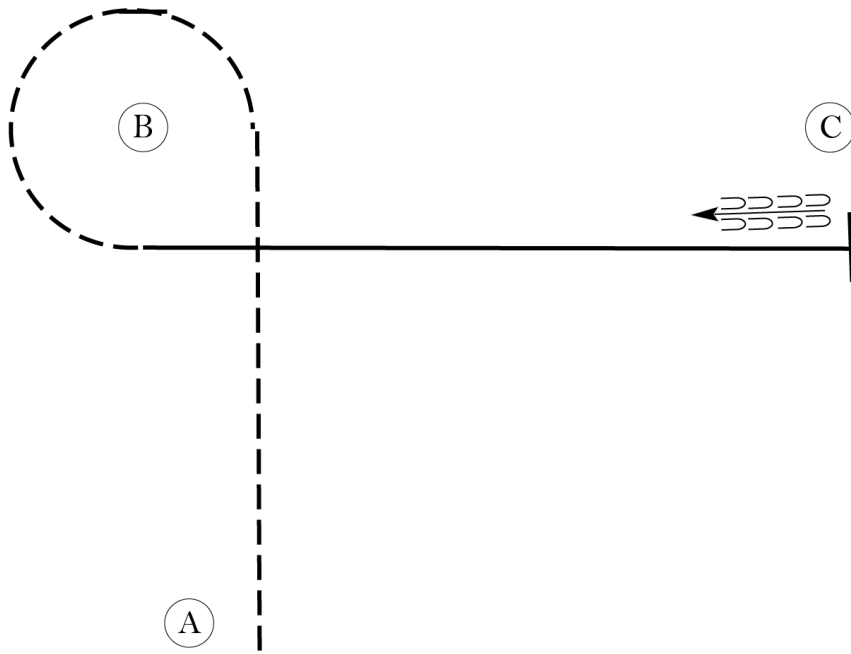

1. Sitting trot A to B.
2. Posting trot around B.
3. At B canter to C.
4. Stop at C.
5. Back one horse length.

Walk	-----
Trot	- - - - -
Extended Trot	-----
Canter	—————
Leg Yield	
Lead Change	— / —
Back	← ← ← ← ←
Marker	⊙
Sidepass	← — — — — →
Hand Gallop	—————

[2015HSE/HSE%201-7]

Pattern Provided by:

Montana 4-H State Horse Committee

Montana State 4-H Horse Patterns

English Horsemanship (Level 2)

Show Date:

www.HorseShowPatterns.com

www.HorseShowPatterns.com

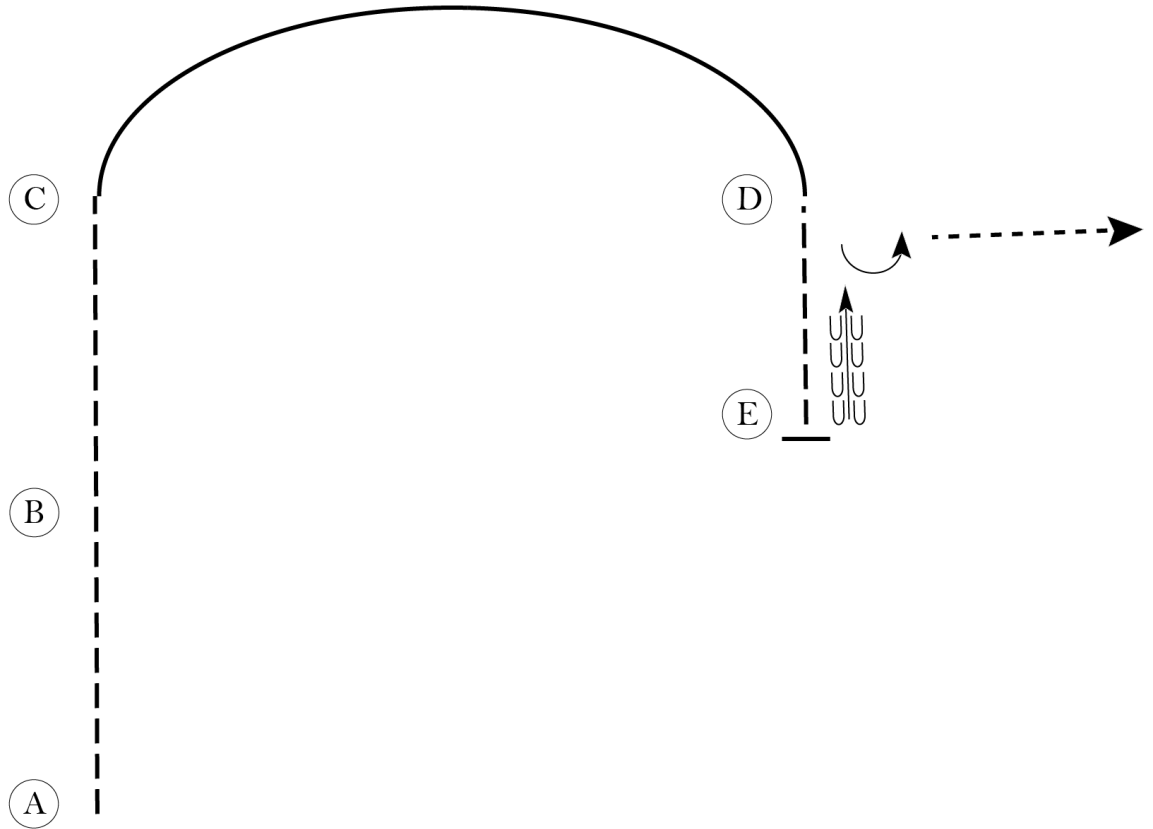

1. Sitting trot A to B.
2. At B, posting trot to C.
3. At C, canter around to D.
4. At D, posting trot to E.
5. Stop at E and back 6 steps.
6. Perform a 90 degree turn left and walk off.

Follow the instructions of your ring steward.

Walk	-----
Trot	- - - - -
Extended Trot	— — — — —
Canter	—————
Leg Yield	
Lead Change	— / —
Back	←←←←←
Marker	⊙ B
Sidepass	← — — — — ←
Hand Gallop	—— — — —

[HSE/1-14]

Pattern Provided by:

Montana 4-H State Horse Committee

Montana State 4-H Horse Patterns

English Horsemanship (Level 2)

Show Date:

www.HorseShowPatterns.com

www.HorseShowPatterns.com

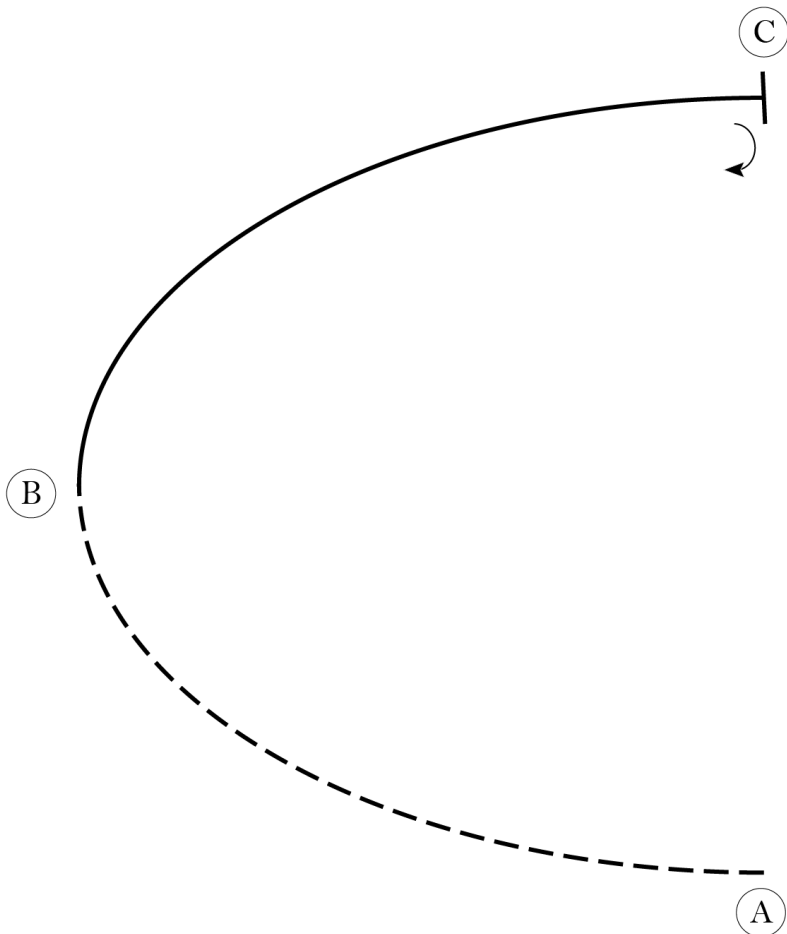

1. Posting trot A to B.
2. At B, canter to C.
3. Stop at C.
4. Turn 90 degrees to the right.

Walk	-----
Trot	- - - - -
Extended Trot	— — — — —
Canter	—————
Leg Yield	
Lead Change	↙ ↘
Back	← ← ← ← ←
Marker	⊙
Sidepass	← — — — — →
Hand Gallop	— — — — —

[2015HSE/HSE%201-13]

Pattern Provided by:

Montana 4-H State Horse Committee

Montana State 4-H Horse Patterns

English Horsemanship (Level 2)

Show Date:

w w w . H o r s e S h o w P a t t e r n s . c o m

w w w . H o r s e S h o w P a t t e r n s . c o m

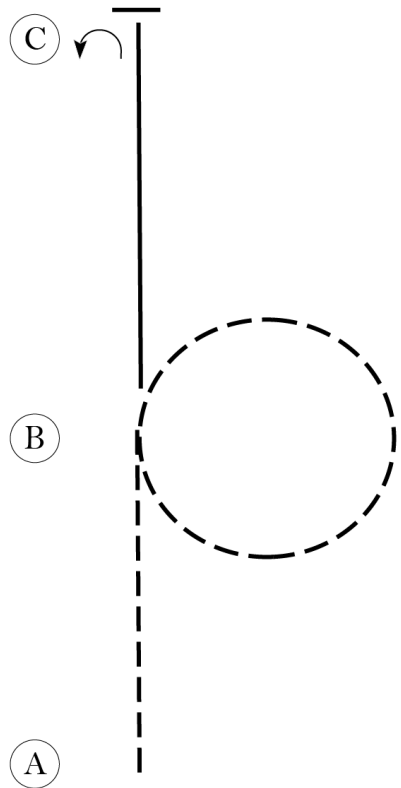

1. Sitting trot A to B.
2. At B, posting trot circle to the right.
3. At B, canter to C.
4. Stop at C and perform a 90 degree turn to the left.

Walk	-----
Trot	- - - - -
Extended Trot	— — — — —
Canter	—————
Leg Yield	
Lead Change	↘ ↘ ↘
Back	← ← ←
Marker	Ⓚ
Sidepass	← — — — — →
Hand Gallop	— — — — —

[HSE/1-2]

Pattern Provided by:

Montana 4-H State Horse Committee

Montana State 4-H Horse Patterns

English Horsemanship (Level 2)

Show Date:

www.HorseShowPatterns.com

www.HorseShowPatterns.com

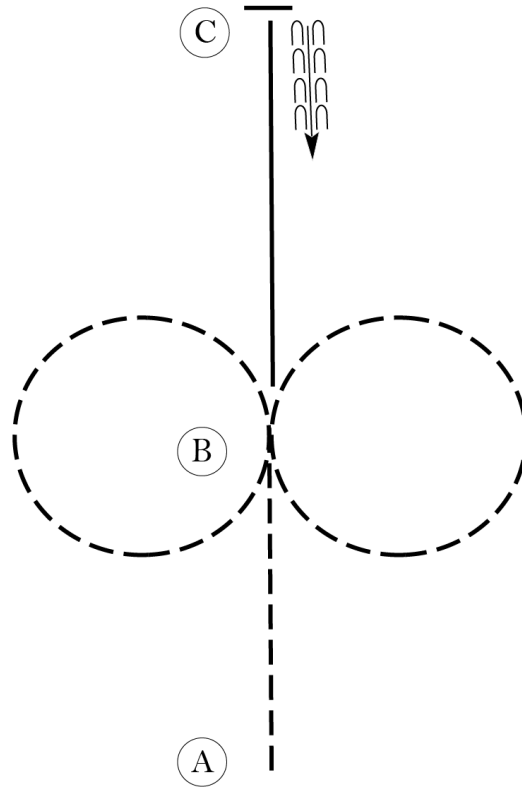

1. Sitting trot A to B.
2. At B, posting trot circle to the right.
3. At B, posting trot circle to the left.
4. At B, canter to C.
5. At C, stop and back 4 steps.

Walk	-----
Trot	- - - - -
Extended Trot	— — — — —
Canter	—————
Leg Yield	
Lead Change	↙ ↘
Back	← ← ← ← ←
Marker	⊙
Sidepass	← — — — — →
Hand Gallop	— — — — —

[HSE/1-6]

Pattern Provided by:

Montana 4-H State Horse Committee

Montana State 4-H Horse Patterns

English Horsemanship (Level 3)

Show Date:

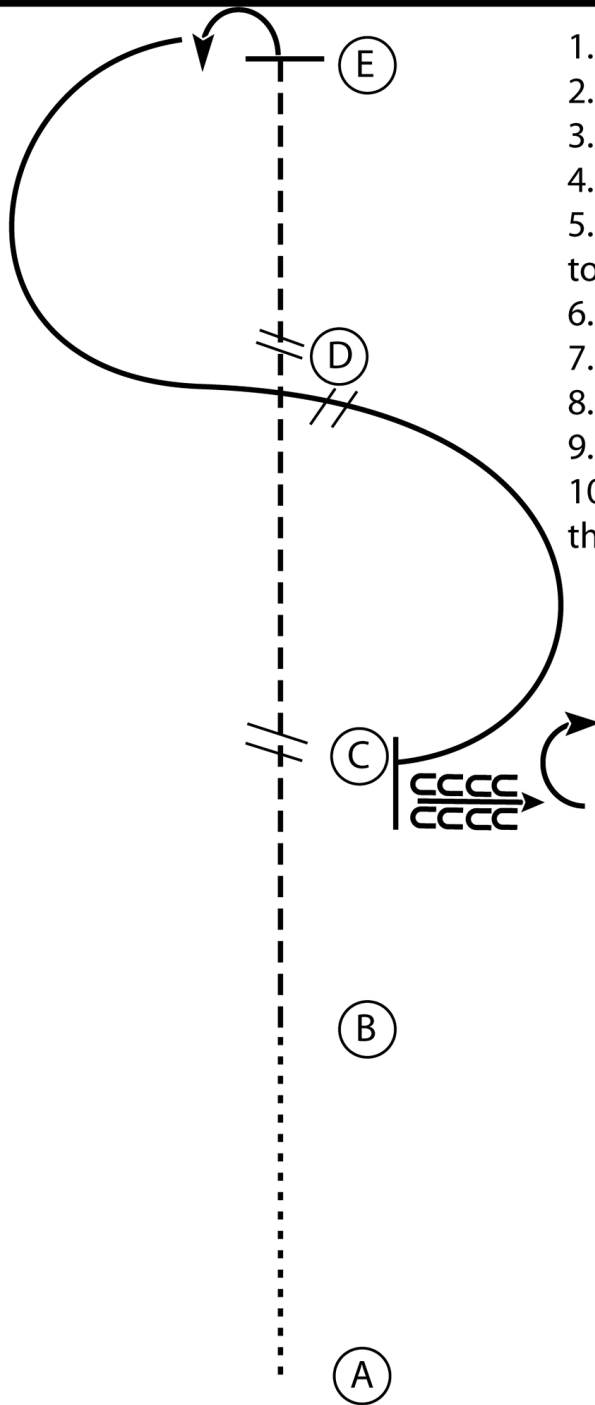

1. Walk A to B
2. Posting trot on the right diagonal B to C
3. Posting trot on the left diagonal C to D
4. Posting trot right diagonal D to E
5. Stop at E and perform a 90 degree turn to the left
6. Canter a half circle on the left lead to D
7. At D perform a lead change
8. Canter a half circle on the right lead to C
9. At C stop and back 4 steps
10. Perform a 90 degree turn to the right on the forehand

Walk
Trot	-----
Extended Trot	-----
Canter	—————
Leg Yield	
Lead Change	⚡
Back	←←←←
Marker	Ⓚ
Sidepass	←←←←

[HSE/3-4]

Pattern Provided by:

Montana 4-H State Horse Committee

www.HorseShowPatterns.com

www.HorseShowPatterns.com

Montana State 4-H Horse Patterns

English Horsemanship (Level 3)

Show Date:

www.HorseShowPatterns.com

www.HorseShowPatterns.com

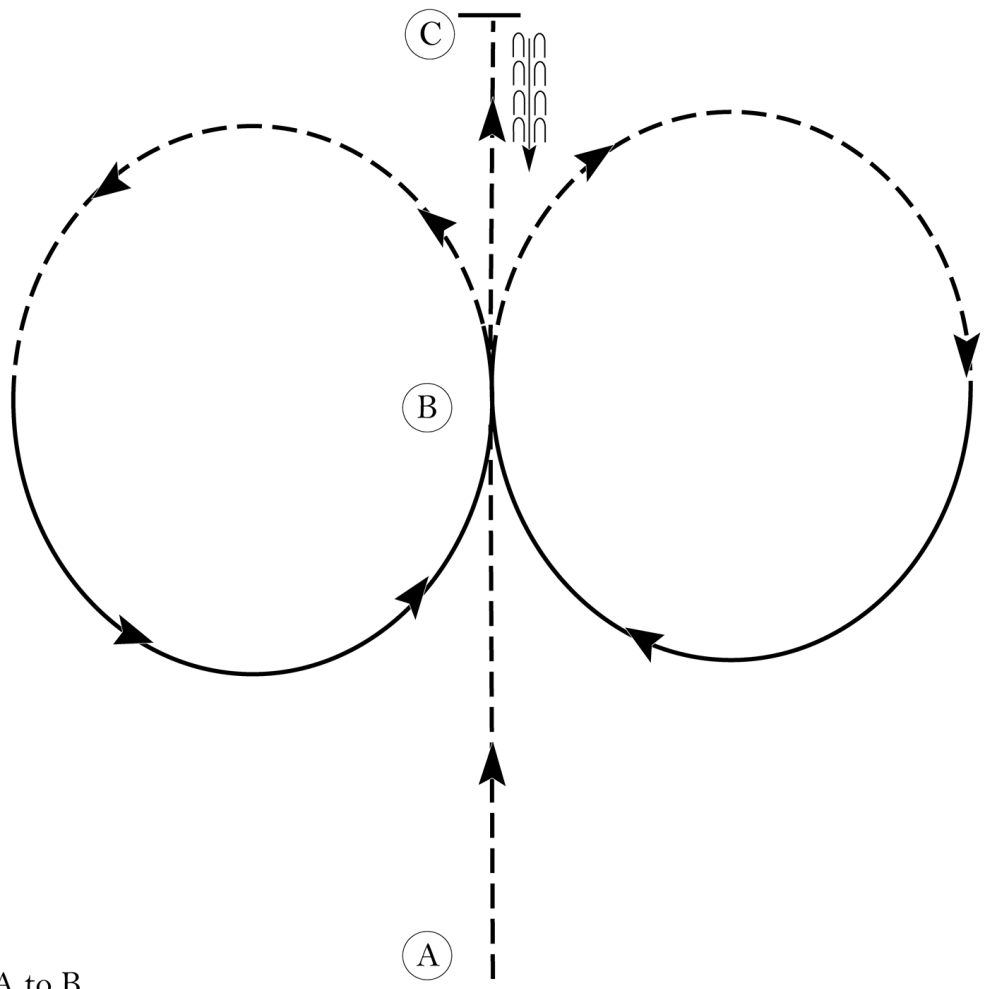

1. Sitting trot A to B
2. At B posting trot on the left diagonal in a half circle.
3. Canter on the right lead back to B.
4. Posting trot on the right diagonal in a half circle.
5. Canter on the left lead back to B.
6. Sitting trot to C.
7. Stop at C and back approximately one horse length.

Exit at a sitting trot.

Walk
Trot	-----
Extended Trot	-----
Canter	—————
Leg Yield	
Lead Change	///
Back	←←←←
Marker	(B)
Sidepass	←-----←
Hand Gallop	—————

[HSE/2-21]

Pattern Provided by:

Montana 4-H State Horse Committee

Montana State 4-H Horse Patterns

English Horsemanship (Level 3)

Show Date:

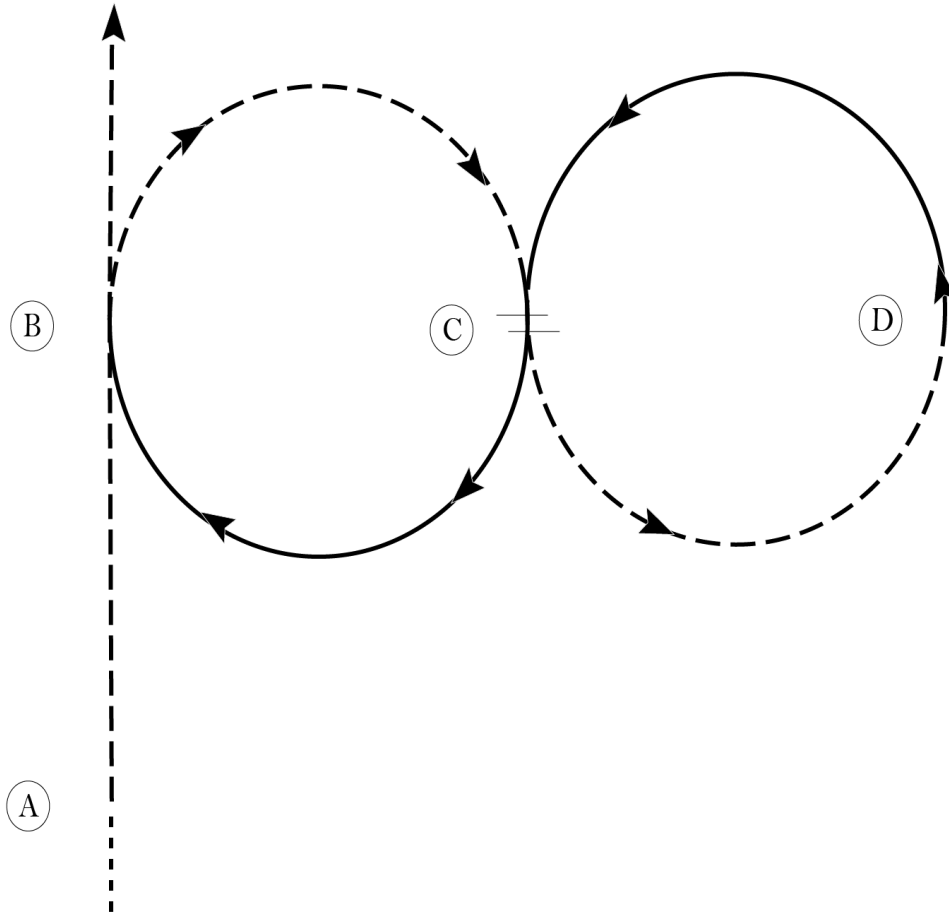

Be ready before A. Walk to A.

1. Sitting trot A to B.
2. At B posting trot a half circle to C on the left diagonal.
3. At C, change diagonals and trot a half circle to D.
4. At D canter a half circle to C on the left lead.
5. At C perform a lead change and canter a half circle to B on the right lead.
6. Sitting trot at B.

Follow the instructions of your ring steward.

Walk	-----
Trot	- - - - -
Extended Trot	-----
Canter	—————
Leg Yield	
Lead Change	↙ ↘ ↙ ↘
Back	← ← ← ← ←
Marker	⊙
Sidepass	← - - - - →
Hand Gallop	—————

[HSE/3-34]

Pattern Provided by:

Montana 4-H State Horse Committee

www.HorseShowPatterns.com

www.HorseShowPatterns.com

Montana State 4-H Horse Patterns

English Horsemanship (Level 3)

Show Date:

www.HorseShowPatterns.com

www.HorseShowPatterns.com

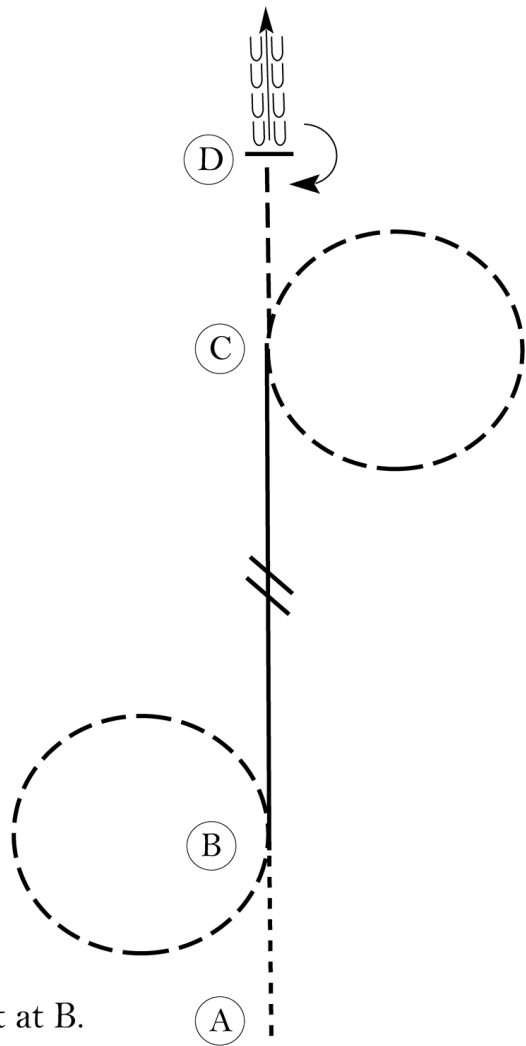

Be ready before A.

1. Walk A to B.
2. Posting trot a circle to the left at B.
3. Canter on the left lead halfway to C.
4. Change leads halfway to C.
5. Canter on the right lead to C.
6. Posting trot a circle to the right at C.
7. Sitting trot from C to D.
8. Stop at D.
9. Perform a 180 degree turn to the right on the forehand.
10. Back approximately one horse length.

Follow the instructions of your ring steward.

Walk	-----
Trot	- - - - -
Extended Trot	-----
Canter	—————
Leg Yield	
Lead Change	↘ ↙
Back	← ← ← ← ←
Marker	(B)
Sidepass	← — — — — →
Hand Gallop	—————

[HSE/3-42]

Pattern Provided by:

Montana 4-H State Horse Committee

Montana State 4-H Horse Patterns

English Horsemanship (Level 3)

Show Date:

www.HorseShowPatterns.com

www.HorseShowPatterns.com

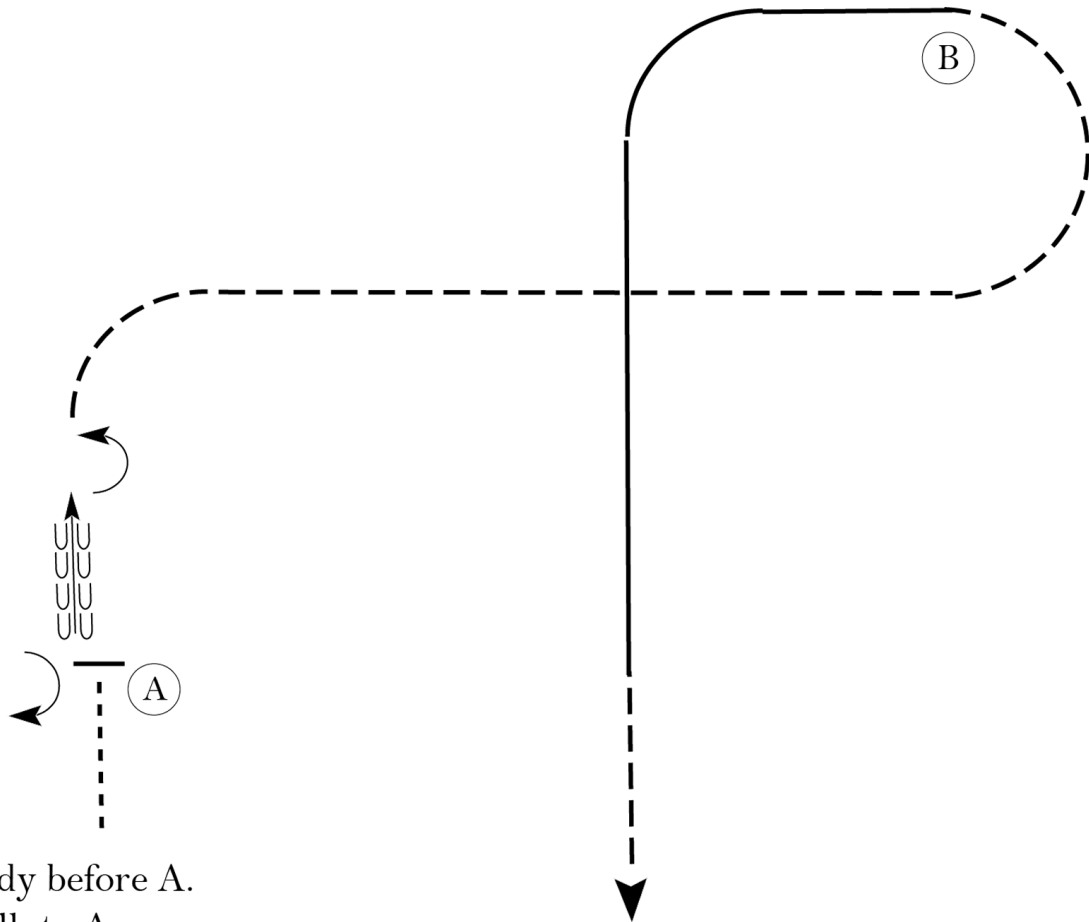

Be ready before A.

1. Walk to A.
2. Perform a 180 degree turn on the forehand right.
3. Back approximately one horse length.
4. Perform a 180 degree turn on the forehand left.
5. Posting trot on the left diagonal to center of pattern.
6. Change diagonals at center. Trot on the right diagonal to B.
7. Canter on the left lead until even with A.
8. Sitting trot three strides past A.

Follow the instructions of your ring steward.

Walk	-----
Trot	- - - - -
Extended Trot	— — — — —
Canter	—————
Leg Yield	
Lead Change	↘
Back	←←←←←
Marker	Ⓚ
Sidepass	← - - - - ←
Hand Gallop	— — — — —

[HSE/3-66]

Pattern Provided by:

Montana 4-H State Horse Committee

Montana State 4-H Horse Patterns

English Horsemanship (Level 3)

Show Date:

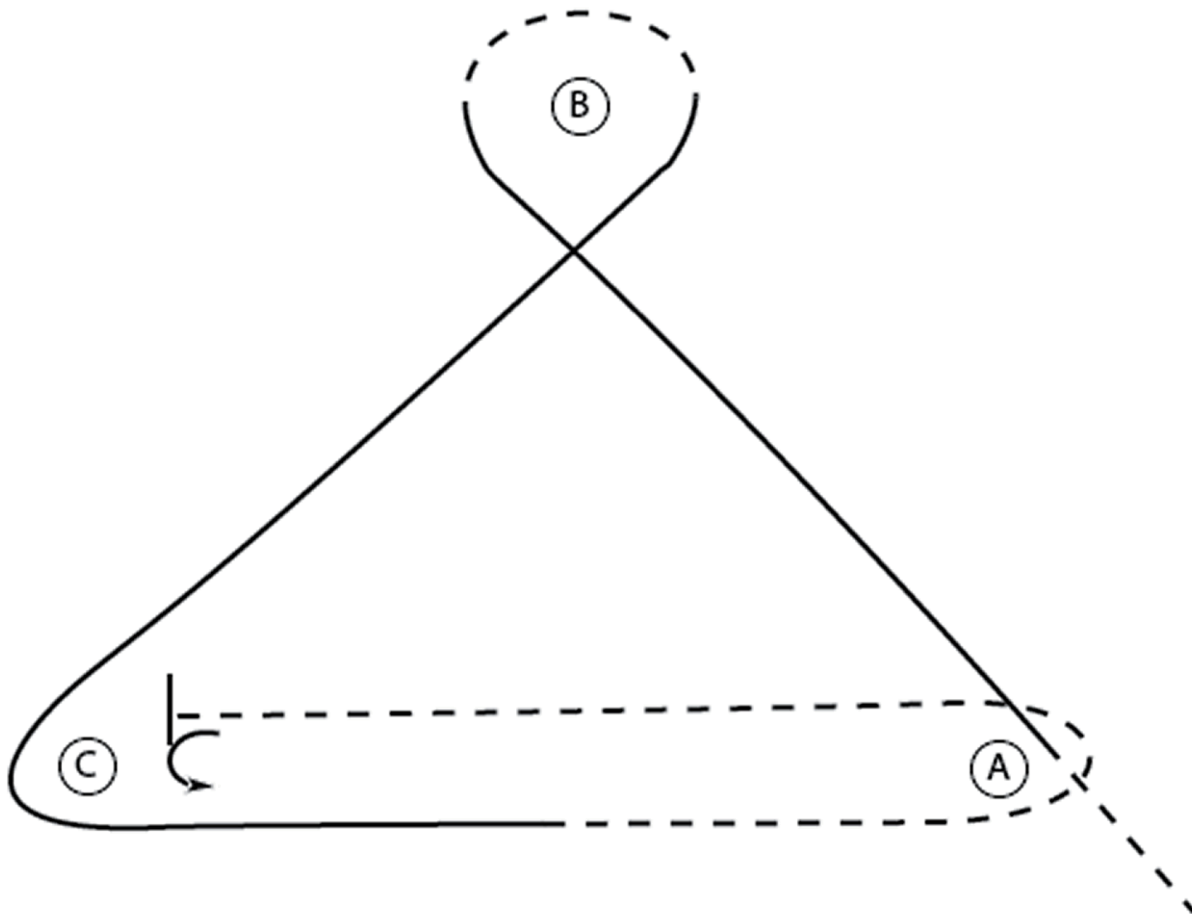

1. Trot to A then canter on the right lead A to B
2. At B posting trot around B
3. At B canter on the left lead to and around C and continue towards A
4. Halfway to A posting trot on the right diagonal to and around A and continue towards C
5. Halfway to C sit the trot
6. Stop at C
7. Perform a 90 degree forehand turn to the left.

Walk
Trot	- - - - -
Extended Trot	— — — — —
Canter	—————
Leg Yield	
Lead Change	↘
Back	←←←←←
Marker	⊙
Sidepass	←←←←←

[2015HSE/H2-4]

Pattern Provided by:

Montana 4-H State Horse Committee

www.HorseShowPatterns.com

www.HorseShowPatterns.com

Montana State 4-H Horse Patterns

English Horsemanship (Level 4)

Show Date:

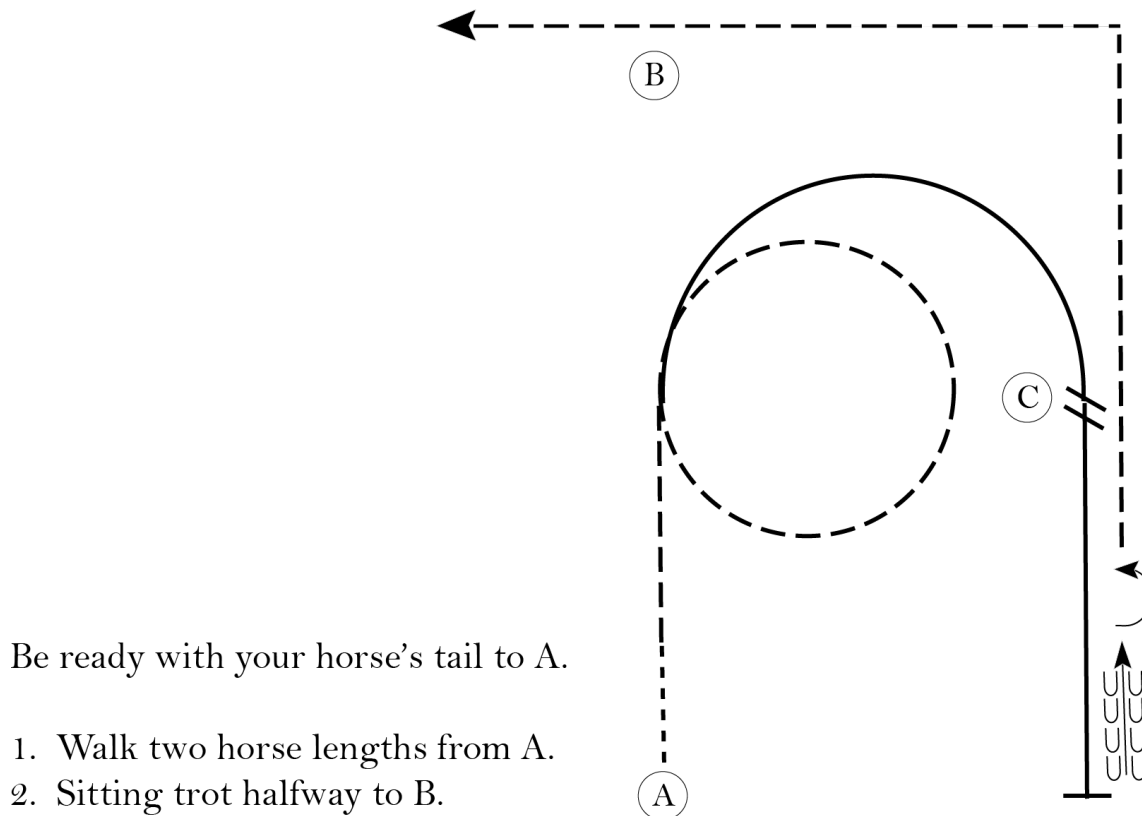

Be ready with your horse's tail to A.

1. Walk two horse lengths from A.
2. Sitting trot halfway to B.
3. Rising trot circle to the right in the left diagonal.
4. Canter a half circle to C in the right lead.
5. Perform a simple lead change at C.
6. Canter until even with A in the left lead.
7. Stop when even with A and back approximately one horse length.
8. Perform a 1/2 turn on the forehand to the left.
9. Rising trot on the right diagonal until even with B. Trot around the corner toward B.
10. Continue to trot past B.

Pattern is over once you have passed B at the trot.

Follow the directions of your ring steward.

Walk	-----
Trot	- - - - -
Extended Trot	— — — —
Canter	—————
Lead Change	
Back	
Marker	(B)
Hand Gallop	—————

[2015HSE/HSE%203-51]

Pattern Provided by:

Montana 4-H State Horse Committee

Montana State 4-H Horse Patterns

English Horsemanship (Level 4)

Show Date:

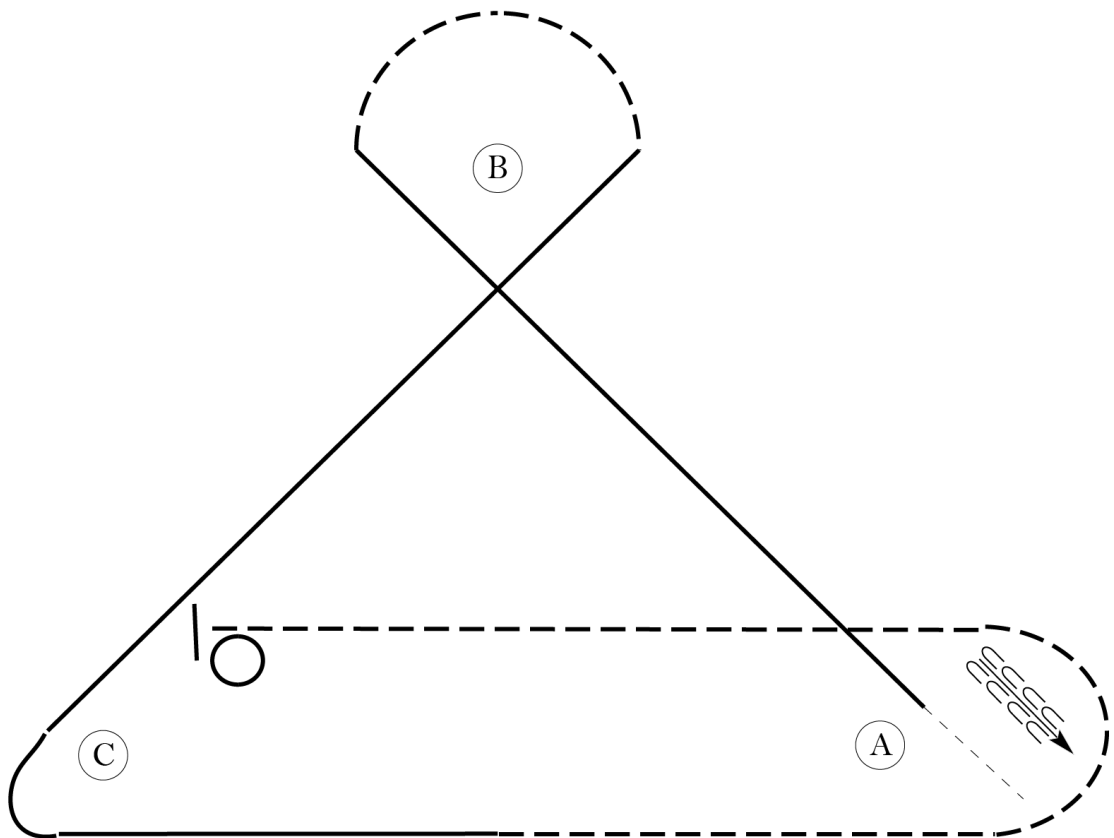

Be ready at A.

1. Back approximately two horse lengths then walk to A.
2. Canter on the right lead to B.
3. At B, posting trot around B in the left diagonal.
4. At B, canter on the left lead to and around C and continue towards A.
5. Halfway to A, posting trot on the right diagonal to and around A and continue towards C.
6. Halfway to C, sit the trot.
7. Stop at C.
8. Perform a 360 degree pivot on the forehand (either direction).

Walk	-----
Trot	- - - - -
Extended Trot	-----
Canter	—————
Leg Yield	
Lead Change	↙ ↘
Back	← ← ← ← ←
Marker	⊙
Sidepass	← →
Hand Gallop	-----

[2015HSE/HSE%202_4_NEW]

Pattern Provided by:

Montana 4-H State Horse Committee

www.HorseShowPatterns.com

www.HorseShowPatterns.com

Montana State 4-H Horse Patterns

English Horsemanship (Level 4)

Show Date:

www.HorseShowPatterns.com

www.HorseShowPatterns.com

1. Walk from A until even with B
2. Stop and perform a 90 degree turn to the right on the forehand
3. Sitting trot to B
4. At B leg yield to C
5. At C canter a circle to the right on the right lead
6. At C perform a simple lead change and continue to D
7. Posting trot D to E on the left diagonal
8. Stop at E

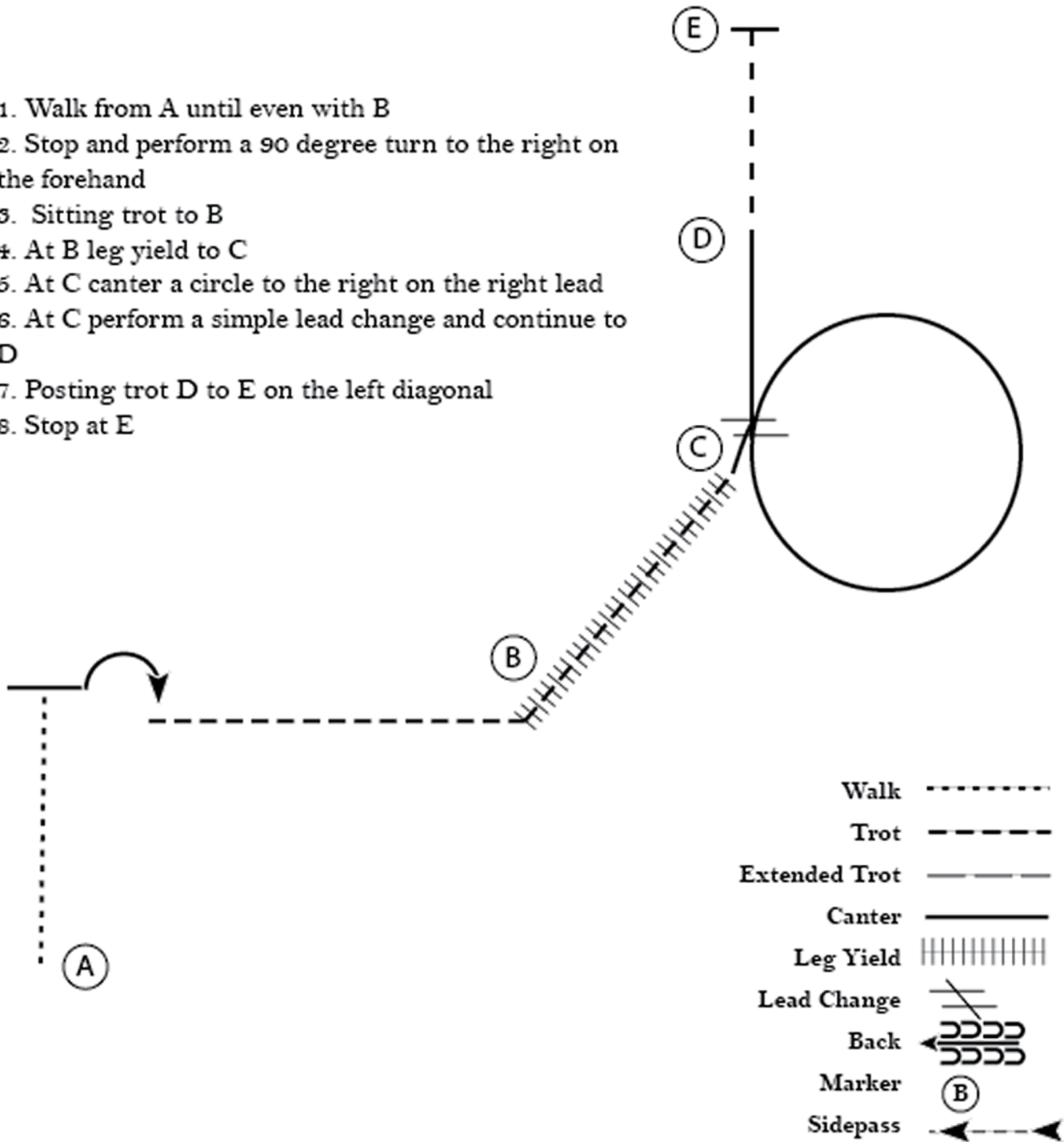

[2015HSE/H3-3]

Pattern Provided by:

Montana 4-H State Horse Committee

Montana State 4-H Horse Patterns

English Horsemanship (Level 4)

Show Date:

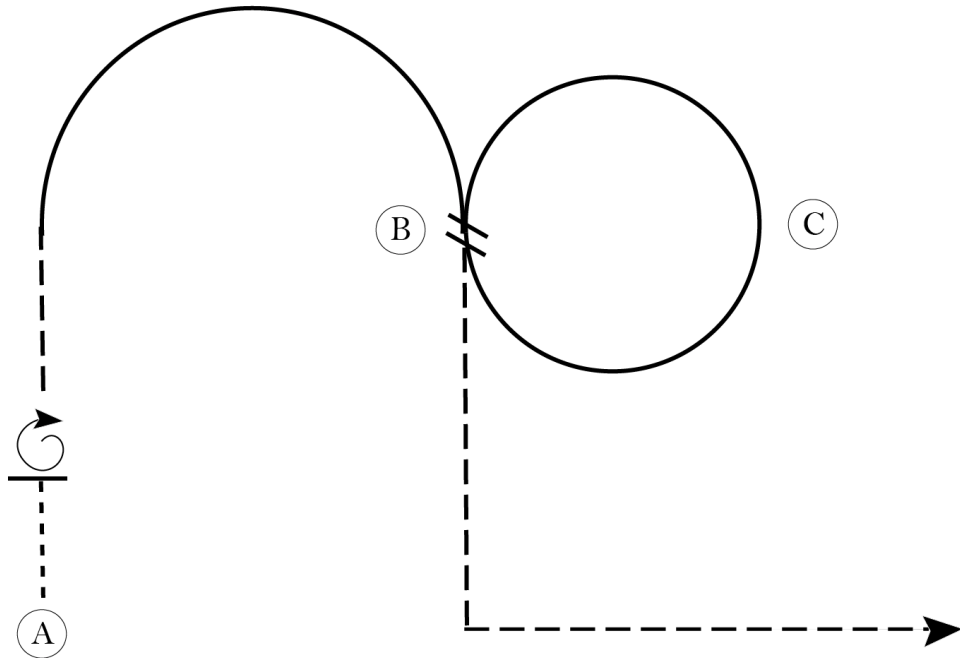

Be ready with your horse's tail to A.

1. Walk two horse lengths from A.
2. Stop and perform a 360 degree turn on the forehand to the right.
3. Sitting trot until even with B then canter on the right lead in a half circle to B.
4. Perform a simple lead change at B.
5. Canter a circle to the left at B.
6. Rising trot on the left diagonal until even with A.
7. Turn left and change diagonals.
8. Rising trot on the right diagonal straight away from A.

Pattern is over once you have passed C at the trot.

Follow the directions of your ring steward.

Walk	-----
Trot	-----
Extended Trot	-----
Canter	-----
Lead Change	////
Back	←○○○○
Marker	○B
Hand Gallop	-----

[2015HSE/HSE%203-46]

Pattern Provided by:

Montana 4-H State Horse Committee

Montana State 4-H Horse Patterns

English Horsemanship (Level 4)

Show Date:

www.HorseShowPatterns.com

www.HorseShowPatterns.com

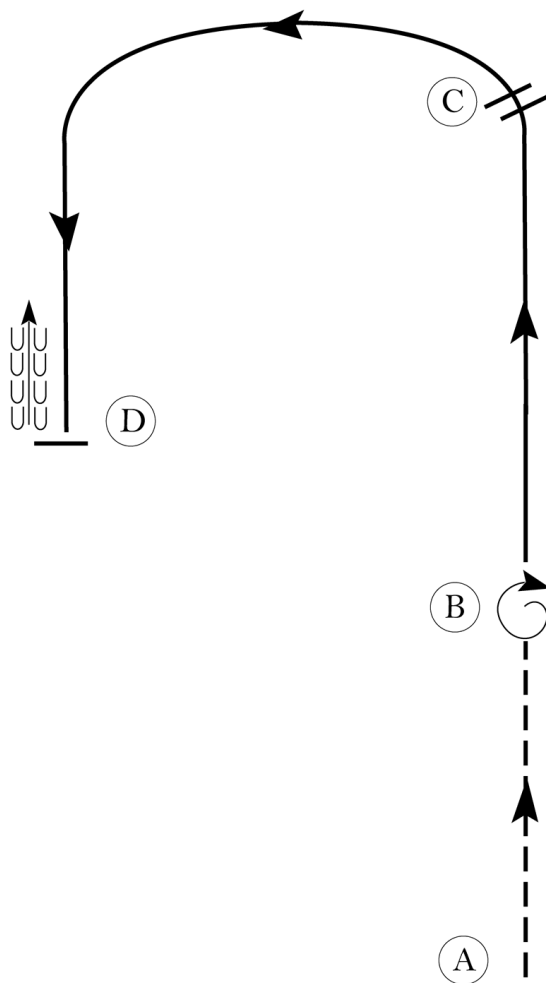

Be ready at A.

1. Posting trot on the left diagonal from A to B.
2. Stop at B and turn on the forehand 360 degrees to the right.
3. Canter on the right lead from B to C.
4. Change leads at C.
5. Canter on the left lead to D.
6. Stop and back approximately one horse length at D.

Exit at a sitting trot.

Walk	-----
Trot	- - - - -
Extended Trot	— — — — —
Canter	—————
Leg Yield	
Lead Change	— / —
Back	← ← ← ← ←
Marker	(B)
Sidepass	← — — — — ←
Hand Gallop	— — — — —

[HSE/3-22]

Pattern Provided by:

Montana 4-H State Horse Committee

Montana State 4-H Horse Patterns

English Horsemanship (Level 4)

Show Date:

w w w . H o r s e S h o w P a t t e r n s . c o m

w w w . H o r s e S h o w P a t t e r n s . c o m

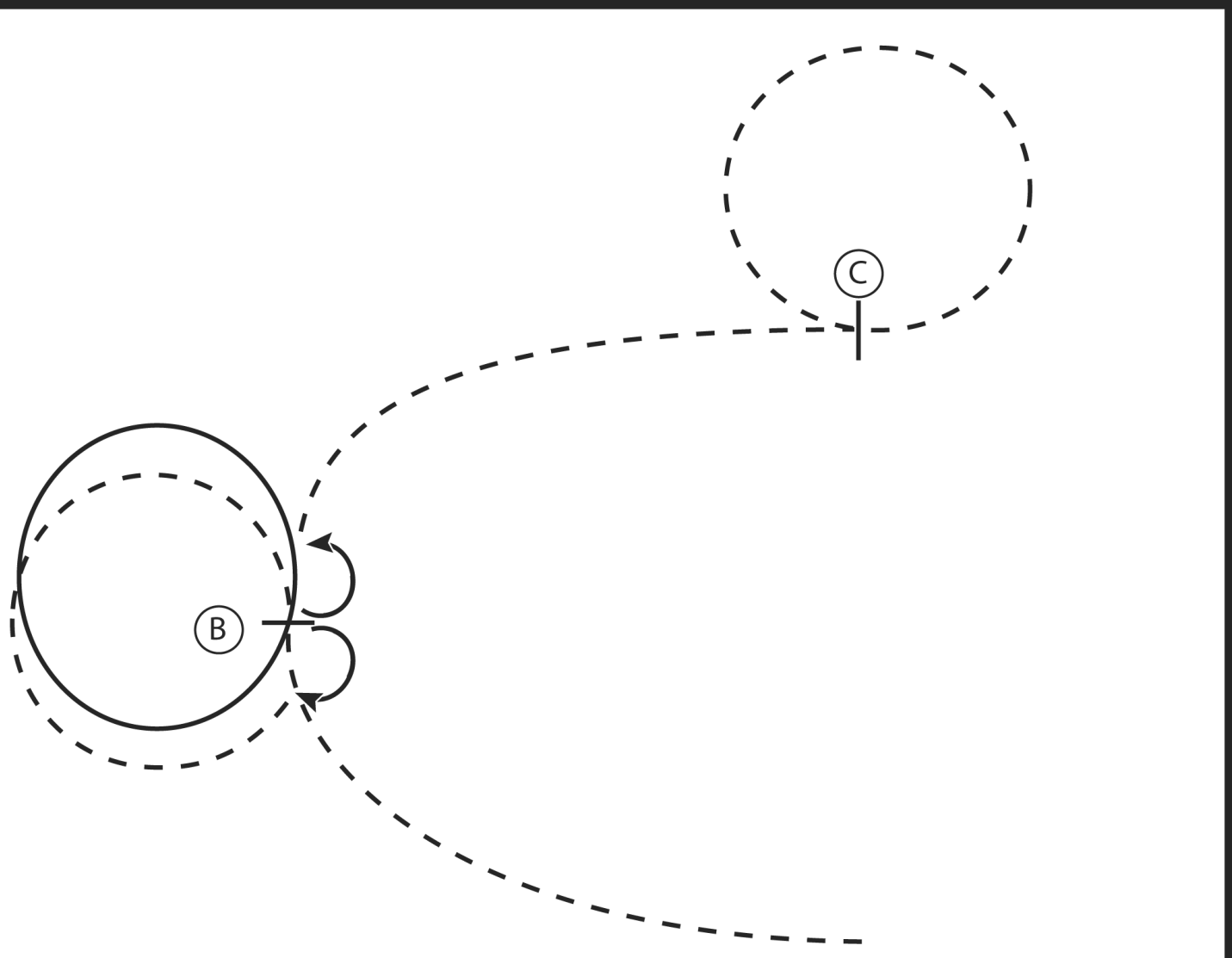

1. Posting trot on the left diagonal A to B
2. Stop at B and perform a 180 degree turn to the right on the forehand
3. Posting trot a circle to the right
4. At B canter a circle to the right on the right lead
5. At B stop and perform a 180 degree turn to the left on the hindquarters
6. Sitting trot to C
7. At C posting trot a circle to the left
8. Stop at C

(A)	Walk
	Trot	-----
	Extended Trot	-----
	Canter	—————
	Leg Yield	
	Lead Change	↙ ↘
	Back	←←←←←
	Marker	(B)
	Sidepass	←-----←

[HSE/3-14]

Pattern Provided by:

Montana 4-H State Horse Committee

Montana State 4-H Horse Patterns

English Horsemanship (Level 4)

Show Date:

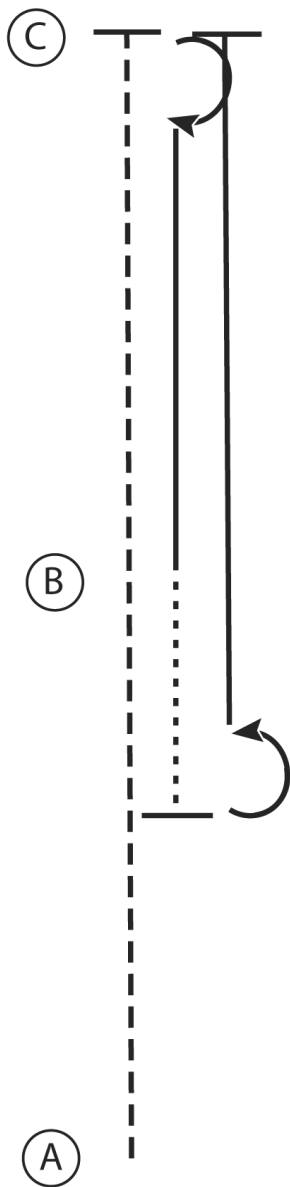

1. Posting trot right diagonal A to B
2. Posting trot left diagonal B to C
3. Stop at C and perform a 180 degree turn to the right on the hindquarter
4. Canter on the right lead C to B
5. At B walk towards A
6. When halfway to A stop and perform a 180 degree turn to the left on the hindquarter
7. Canter on the left lead to C
8. Stop at C

Walk
Trot	- - - - -
Extended Trot	— — — — —
Canter	—————
Leg Yield	
Lead Change	↘
Back	←←←←←
Marker	⊙ (B)
Sidepass	← - - - - →

[HSE/3-6]

Pattern Provided by:

Montana 4-H State Horse Committee

www.HorseShowPatterns.com

www.HorseShowPatterns.com

Montana State 4-H Horse Patterns

English Horsemanship (Level 4)

Show Date:

www.HorseShowPatterns.com

www.HorseShowPatterns.com

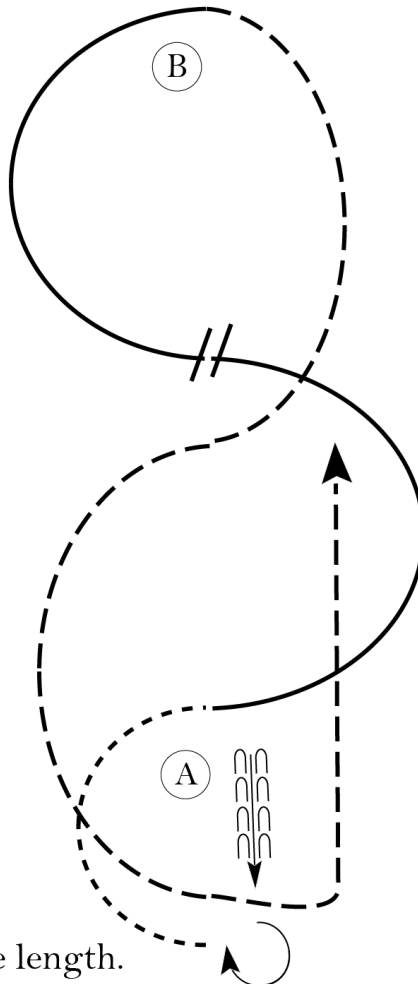

Be ready at A.

1. Back approximately one horse length.
2. Perform a 3/4 turn on the forehand right.
3. Walk around A.
4. Canter on the left lead in a half circle.
5. Change leads and canter on the right lead to B.
6. Break to a posting trot and trot a serpentine to A showing a change of diagonals in center.
7. At A, sitting trot around corner toward B.

Pattern is over once you have trotted past the center point of the pattern.

Follow the instructions of your ring steward.

Walk	-----
Trot	- - - - -
Extended Trot	— — — — —
Canter	—————
Leg Yield	
Lead Change	↘ ↙
Back	← ← ← ← ←
Marker	⊙
Sidepass	← — — — — →
Hand Gallop	— — — — —

[HSE/3-69]

Pattern Provided by:

Montana 4-H State Horse Committee

Montana State 4-H Horse Patterns

English Horsemanship (Level 5)

Show Date:

www.HorseShowPatterns.com

www.HorseShowPatterns.com

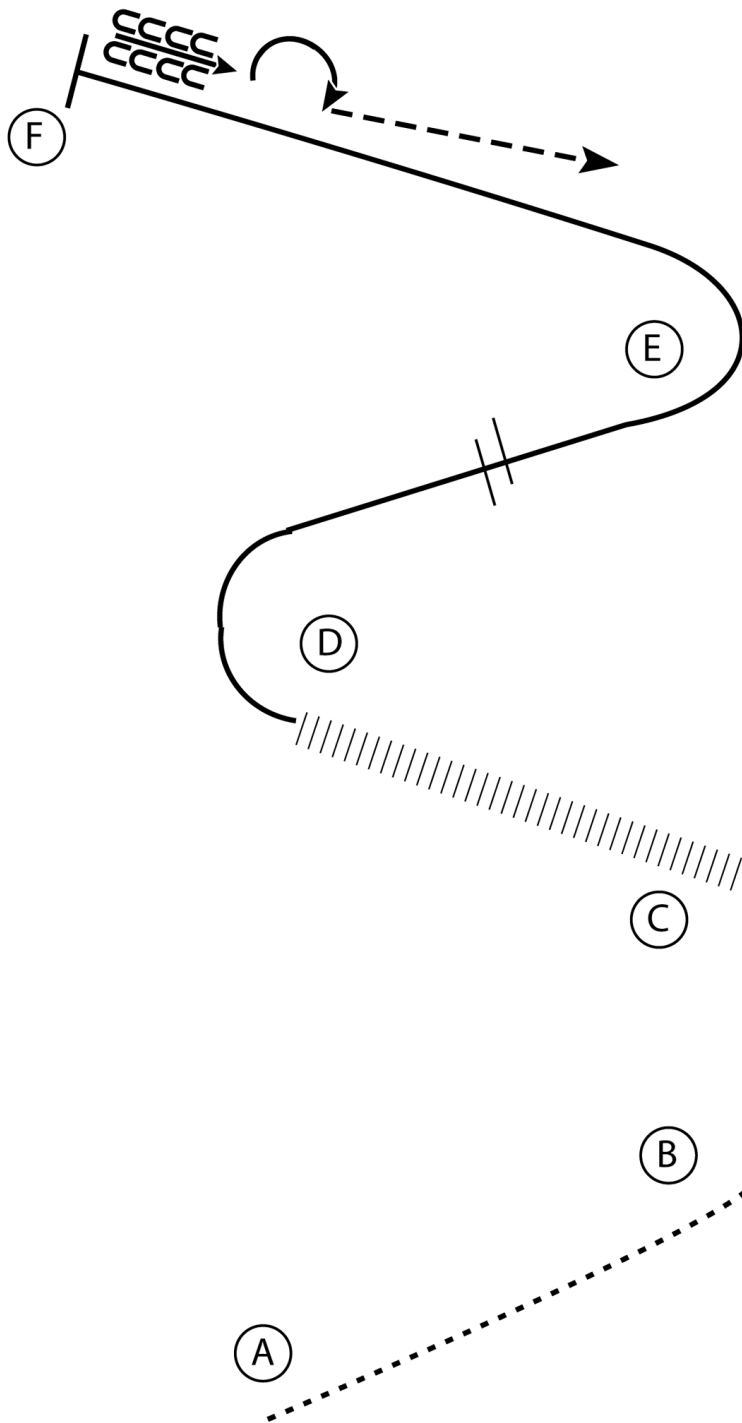

1. Walk A to B
2. Sitting trot B to C
3. Leg yield C to D
4. At D canter on the right lead towards E
5. When halfway to E perform a lead change and continue at the canter around E to F
6. At F stop and back 4 steps
7. Perform a 180 degree turn to the right on the forehand
8. Posting trot on the left diagonal to exit

Walk
Trot	- - - - -
Extended Trot	— — — — —
Canter	—————
Leg Yield	
Lead Change	— / —
Back	←←←←
Marker	⊙
Sidepass	← - - - - ←

[HSE/3-13]

Pattern Provided by:

Montana 4-H State Horse Committee

Montana State 4-H Horse Patterns

English Horsemanship (Level 5)

Show Date:

www.HorseShowPatterns.com

www.HorseShowPatterns.com

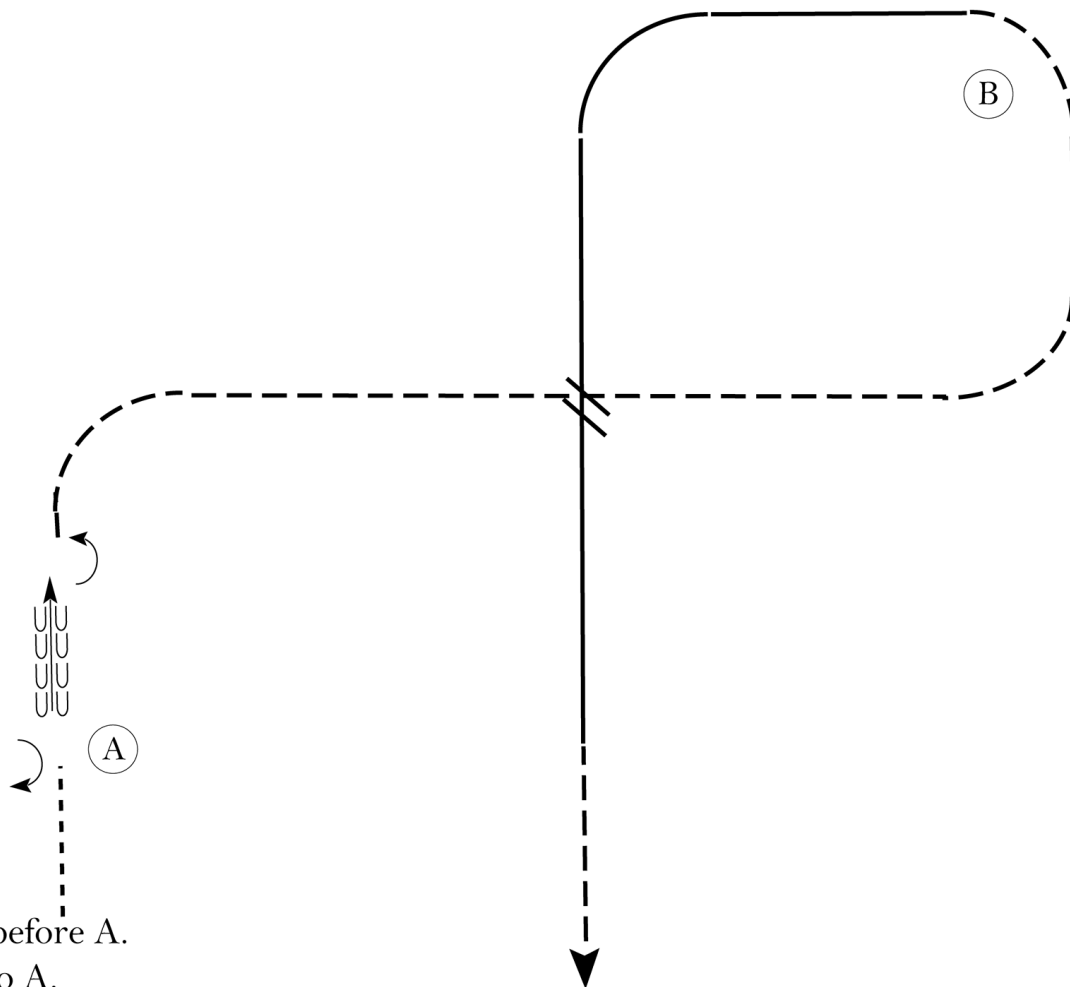

Be ready before A.

1. Walk to A.
2. Perform a 180 degree turn on the forehand right.
3. Back approximately one horse length.
4. Perform a 180 degree turn on the forehand left.
5. Posting trot in the correct diagonal to center of the pattern.
6. Change diagonals at center and trot to B.
7. Canter on the left lead to center of pattern.
8. Change leads at center. Canter on right lead until even with A.
9. Sitting trot when even with A. Pattern is over after trotting 3 strides past A.

Follow the instructions of your ring steward.

Walk	-----
Trot	- - - - -
Extended Trot	-----
Canter	—————
Leg Yield	
Lead Change	↙ ↘
Back	← ← ← ← ←
Marker	⊙
Sidepass	← — — — →
Hand Gallop	—————

[HSE/3-66]

Pattern Provided by:

Montana 4-H State Horse Committee

Montana State 4-H Horse Patterns

English Horsemanship (Level 5)

Show Date:

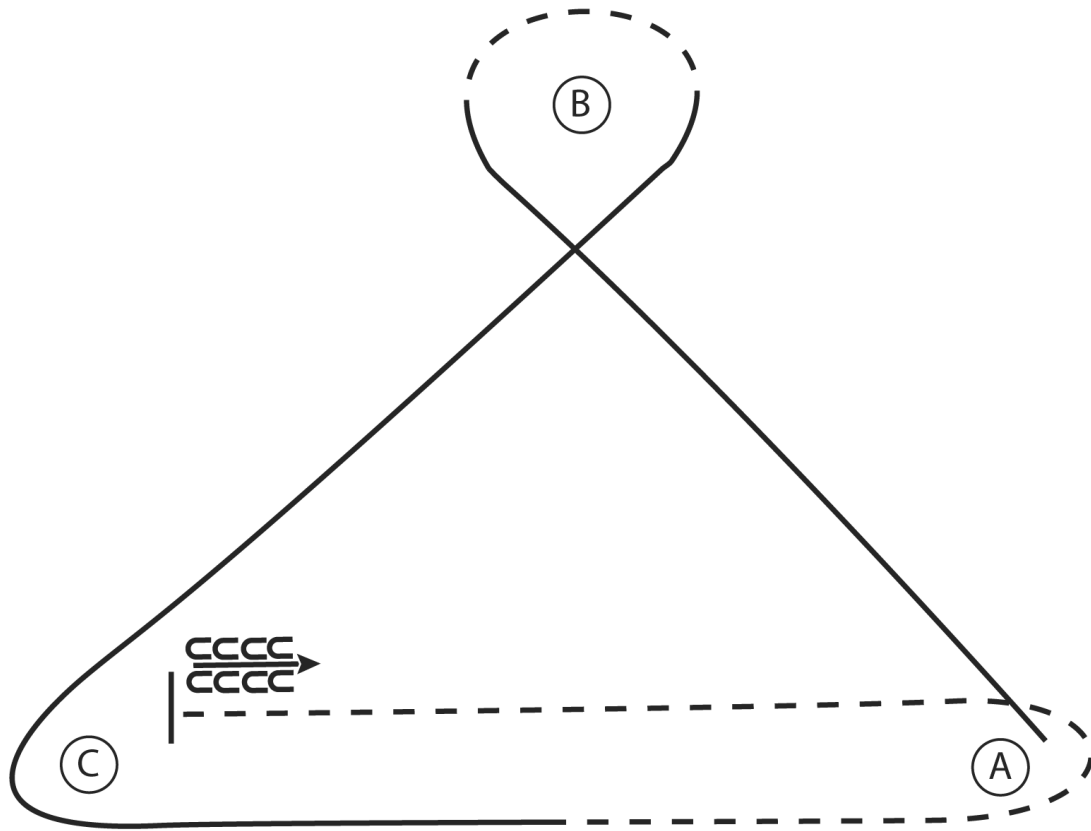

1. Canter in the right lead A to B.
2. At B, posting trot around B.
3. At B, canter in the left lead to and around C and continue towards A.
4. Halfway to A, posting trot in the correct diagonal to and around A and continue towards C.
5. Halfway to C, sit the trot.
6. Stop at C and back four steps.

Walk
Trot	-----
Extended T rot	-----
Canter	—————
Leg Yield	
Lead Change	↙
Back	←←←←
Marker	⊙
Sidepass	←←←←

[HSE/3-5]

Pattern Provided by:

Montana 4-H State Horse Committee

www.HorseShowPatterns.com

www.HorseShowPatterns.com

Montana State 4-H Horse Patterns

English Horsemanship (Level 5)

Show Date:

w w w . H o r s e S h o w P a t t e r n s . c o m

w w w . H o r s e S h o w P a t t e r n s . c o m

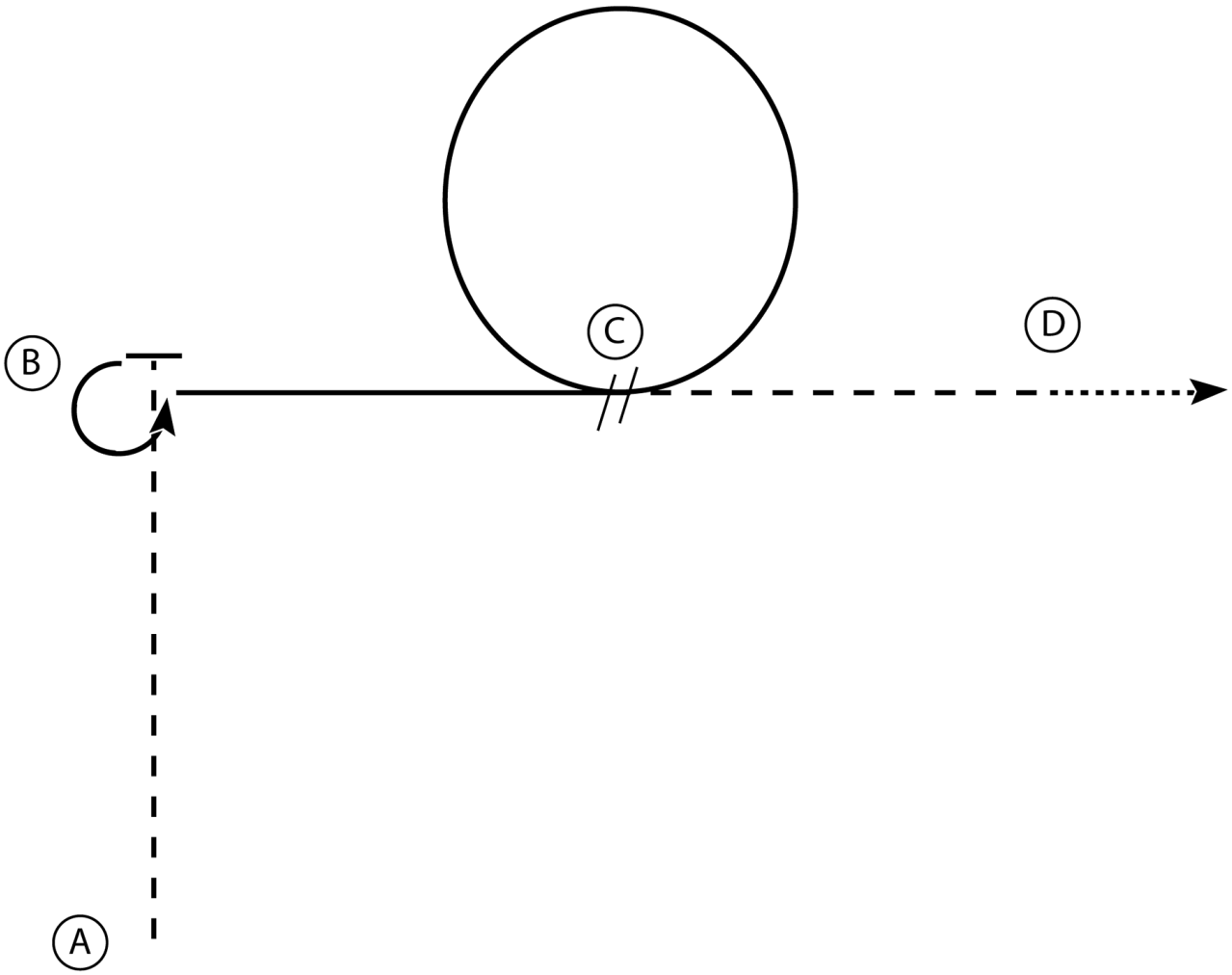

1. Posting trot on the correct diagonal A to B.
2. At B stop and perform a 270 degree turn to the left on the forehand.
3. Canter on the left lead to C.
4. At C perform a lead change and counter canter a circle to the left.
5. At C posting trot on the correct diagonal to D.
6. At D walk to exit.

Walk
Trot	-----
Extended Trot	-----
Canter	—————
Leg Yield	
Lead Change	↘
Back	←←←←←
Marker	⊙
Sidepass	←←←←←

[HSE/3-27]

Pattern Provided by:

Montana 4-H State Horse Committee

Montana State 4-H Horse Patterns

English Horsemanship (Level 5)

Show Date:

www.HorseShowPatterns.com

www.HorseShowPatterns.com

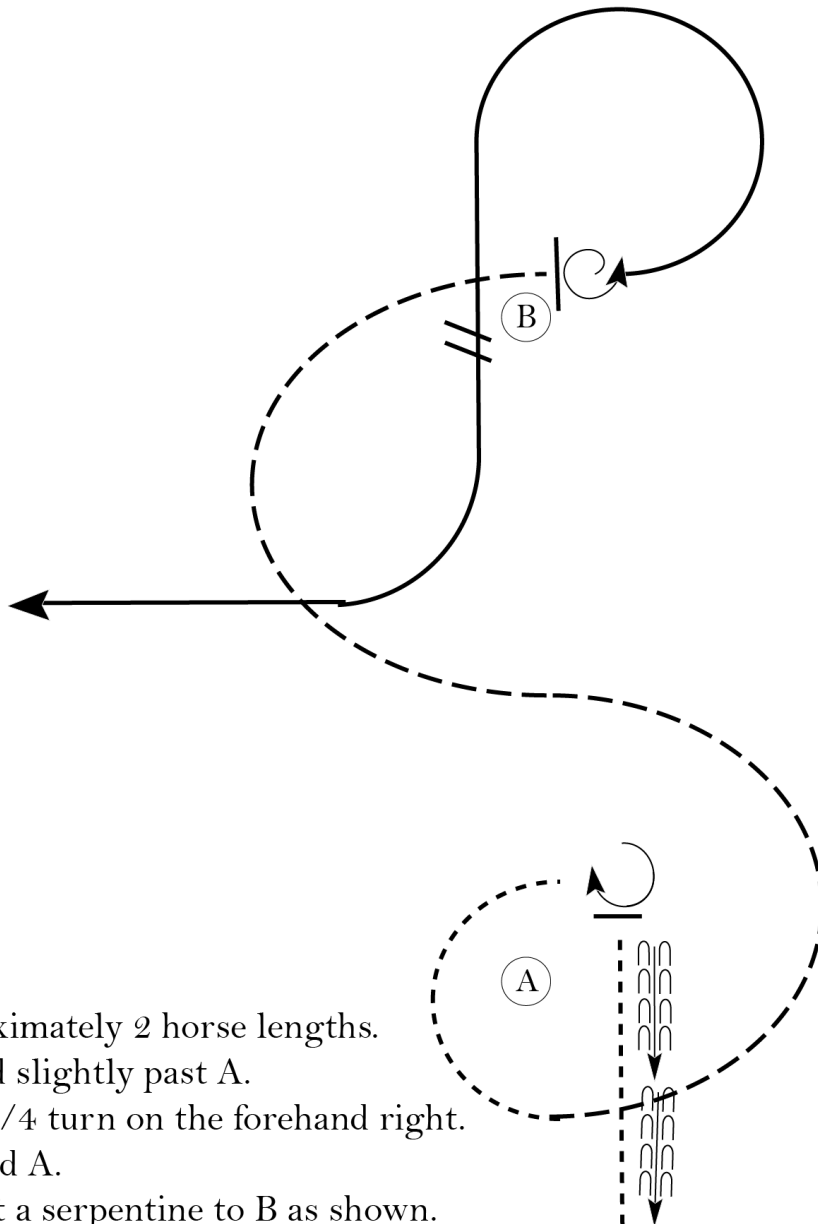

Be ready at A.

1. Back approximately 2 horse lengths.
2. Walk to and slightly past A.
3. Perform a 3/4 turn on the forehand right.
4. Walk around A.
5. Posting trot a serpentine to B as shown.
6. Halt at B. Perform a full turn on the forehand left.
7. Canter on the left lead in a circle to B.
8. Change leads at B and canter on the right lead to exit as shown.

Follow the instructions of your ring steward.

Walk
Trot	- - - - -
Extended Trot	- - - - -
Canter	—————
Leg Yield	
Lead Change	↘↘↘
Back	←←←
Marker	ⓑ
Sidepass	←-←
Hand Gallop	—————

[HSE/3-68]

Pattern Provided by:

Montana 4-H State Horse Committee

Montana State 4-H Horse Patterns

English Horsemanship (Level 5)

Show Date:

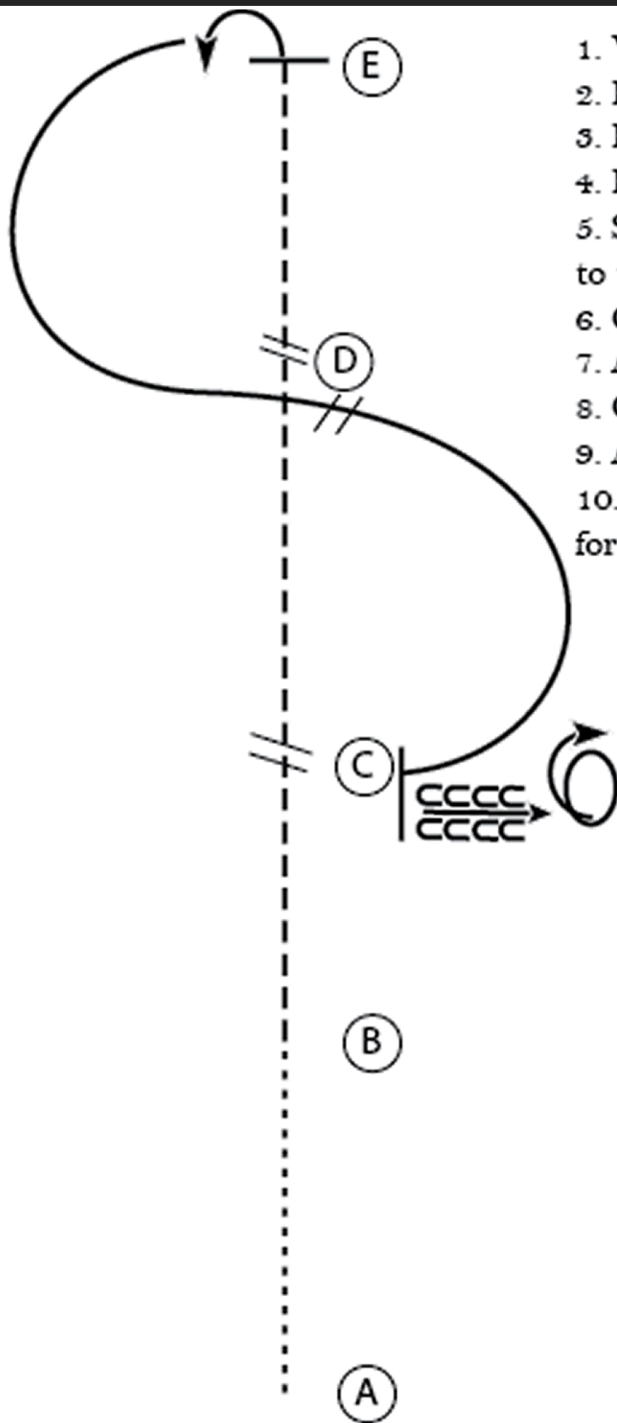

1. Walk A to B
2. Posting trot on the right diagonal B to C
3. Posting trot on the left diagonal C to D
4. Posting trot right diagonal D to E
5. Stop at E and perform a 90 degree turn to the left
6. Canter a half circle on the left lead to D
7. At D perform a lead change
8. Canter a half circle on the right lead to C
9. At C stop and back 4 steps
10. Perform a 1 1/4 turn to the right on the forehand

Walk
Trot	- - - - -
Extended Trot	—————
Canter	—————
Leg Yield	
Lead Change	— / —
Back	← C C C C C
Marker	(B)
Sidepass	← — — — — →

[2015HSE/H3-4]

Pattern Provided by:

Montana 4-H State Horse Committee

www.HorseShowPatterns.com

www.HorseShowPatterns.com

Montana State 4-H Horse Patterns

English Horsemanship (Level 5)

Show Date:

www.HorseShowPatterns.com

www.HorseShowPatterns.com

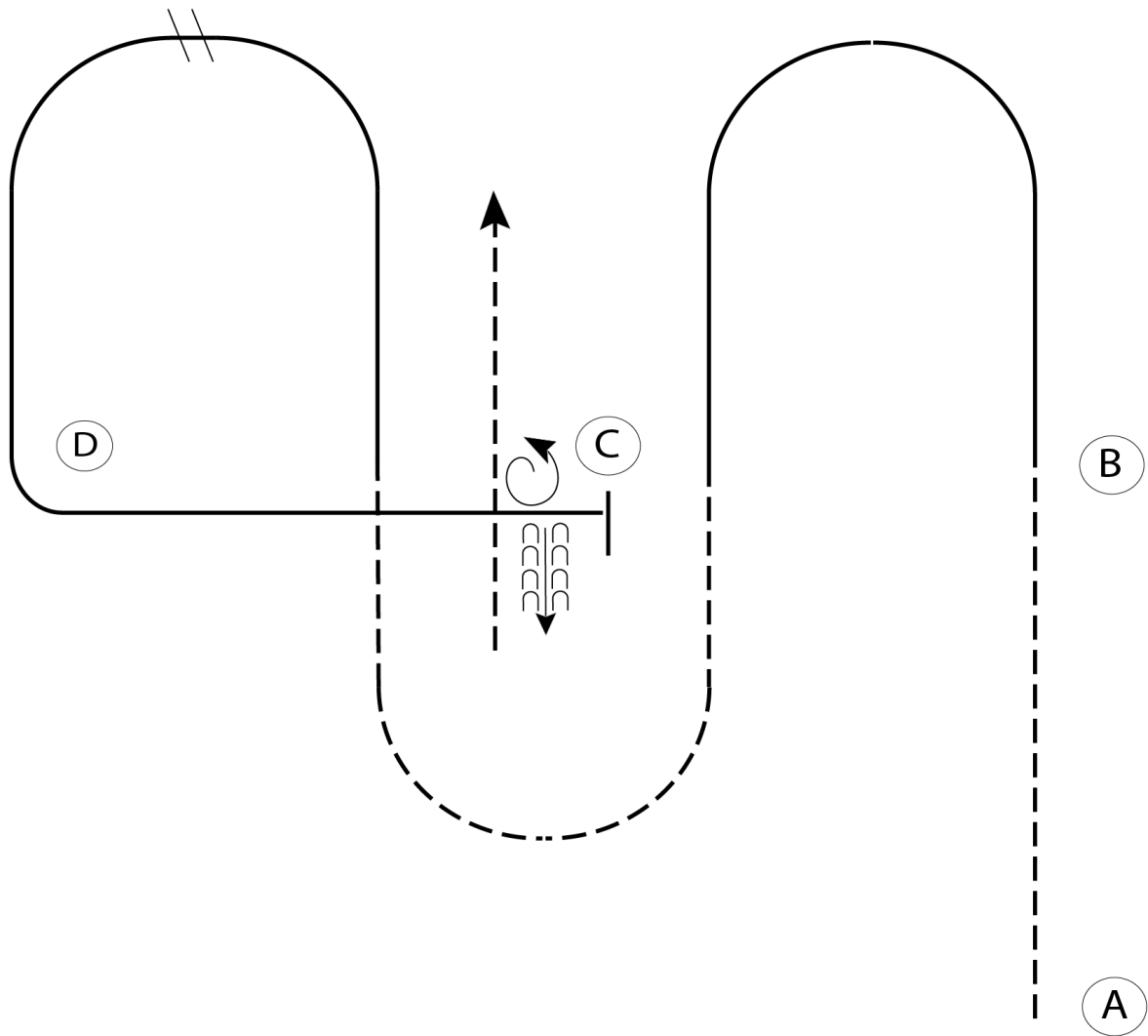

1. Posting trot from A to B on the correct diagonal
2. Canter on the left lead from B to C
3. Sitting trot in a half-circle from C until even with C
4. Canter left lead in a half circle. Halfway to D perform a simple lead change
5. Counter canter around D to C
6. At C stop and perform a 1 1/4 turn on the forehand to the left
7. Back one horse length and trot to the exit

Walk	-----
Trot	- - - - -
Extended Trot	— — — — —
Canter	—————
Leg Yield	
Lead Change	///
Back	←←←←←
Marker	(B)
Sidepass	←←←←←
Hand Gallop	—————

[2015HSE/HSE3-30]

Pattern Provided by:

Montana 4-H State Horse Committee

Montana State 4-H Horse Patterns

English Horsemanship (Level 5)

Show Date:

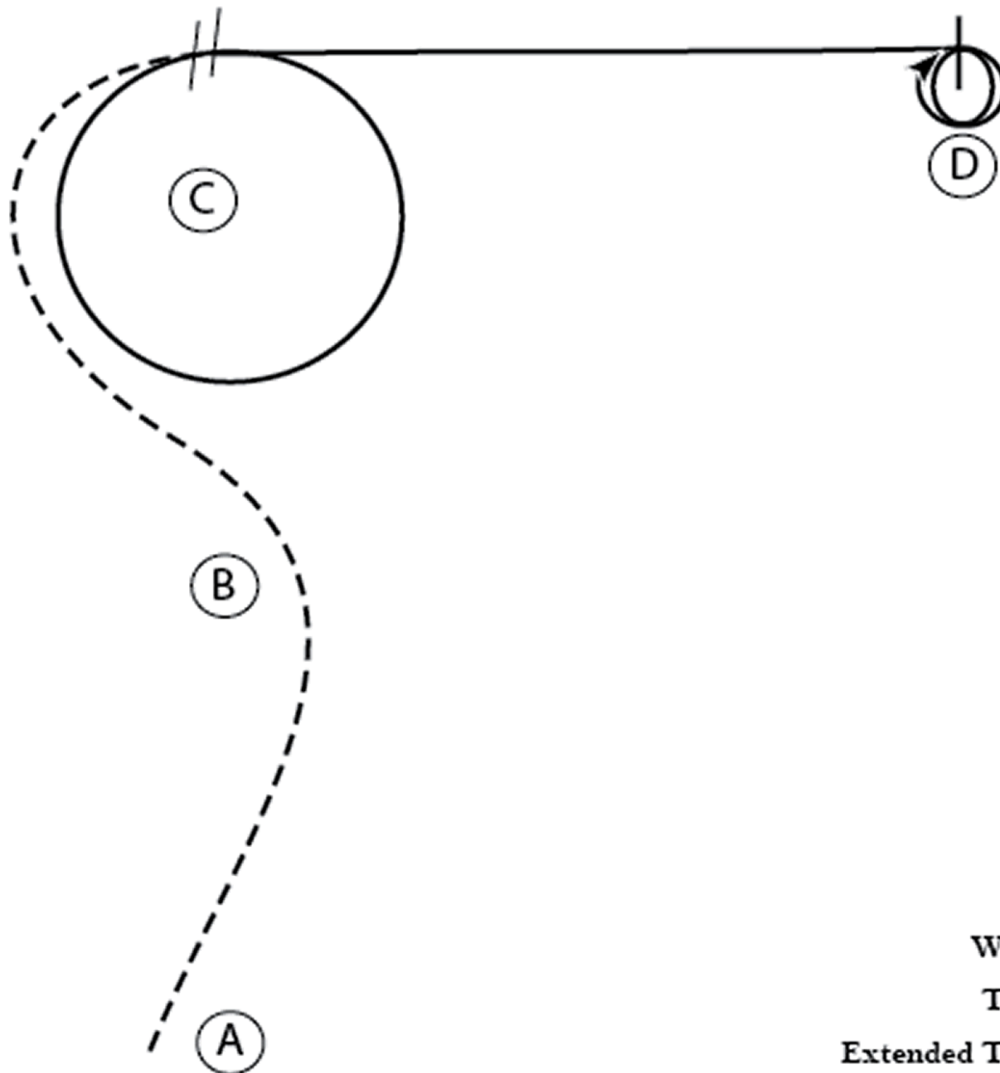

1. Posting trot A to B on the right diagonal
2. At B change diagonals and continue to C
3. At C counter canter a circle to the right on the left lead
4. At C perform a simple lead change and continue to D
5. At D stop and perform two 360 degree turns to the right on the hindquarters

Walk
Trot	-----
Extended Trot	-----
Canter	—————
Leg Yield	
Lead Change	↘
Back	←←← →→→
Marker	⊙ (B)
Sidepass	←-----→

[2015HSE/H3-9]

Pattern Provided by:

Montana 4-H State Horse Committee

www.HorseShowPatterns.com

www.HorseShowPatterns.com

Montana State 4-H Horse Patterns

English Horsemanship (Level 6)

Show Date:

www.HorseShowPatterns.com

www.HorseShowPatterns.com

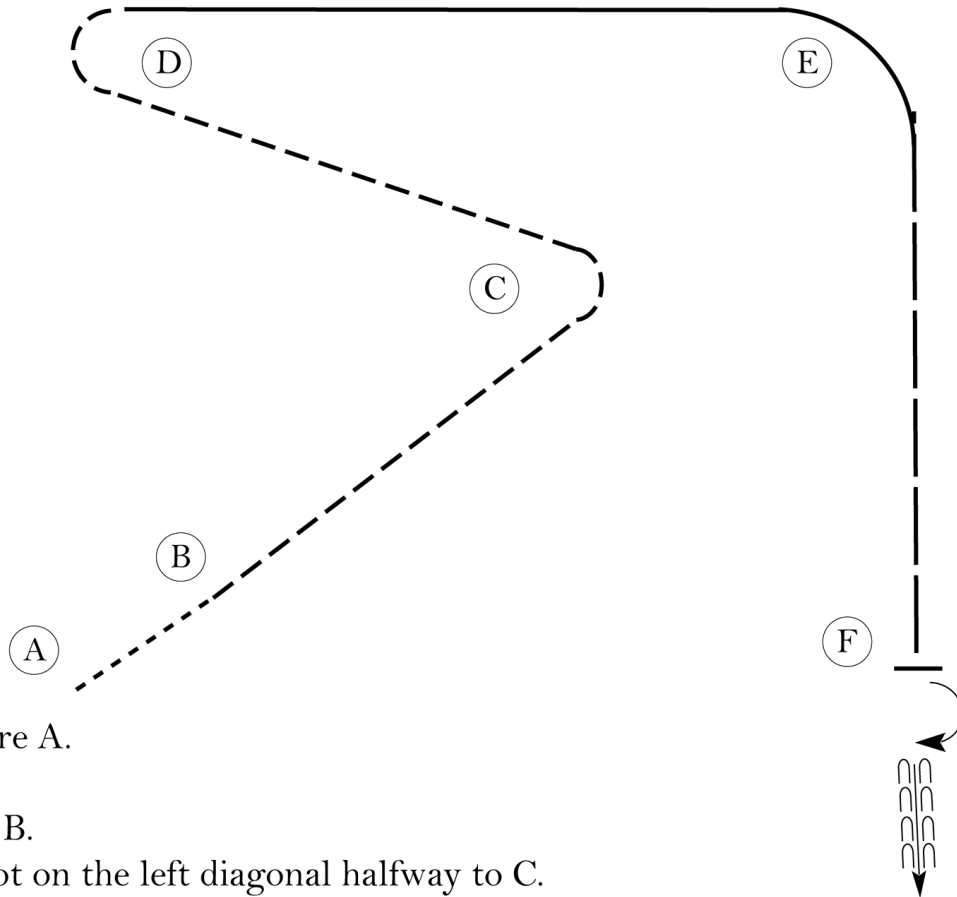

Be ready before A.

1. Walk A to B.
2. Posting trot on the left diagonal halfway to C.
3. Change diagonals and post on the right diagonal halfway to D.
4. Change diagonals and post the trot to and around D.
5. Canter on the right lead to and around E.
6. Hand gallop to F.
7. Halt at F. Turn 180 degrees on the forehand to the right.
8. Back approximately one horse length.

Follow the instructions of your ring steward.

Walk	-----
Trot	- - - - -
Extended Trot	— — — — —
Canter	—————
Leg Yield	
Lead Change	↘ ↘ ↘
Back	← ← ←
Marker	(B)
Sidepass	← — — — — →
Hand Gallop	— — — — —

[HSE/3-64]

Pattern Provided by:

Montana 4-H State Horse Committee

Montana State 4-H Horse Patterns

English Horsemanship (Level 6)

Show Date:

www.HorseShowPatterns.com

www.HorseShowPatterns.com

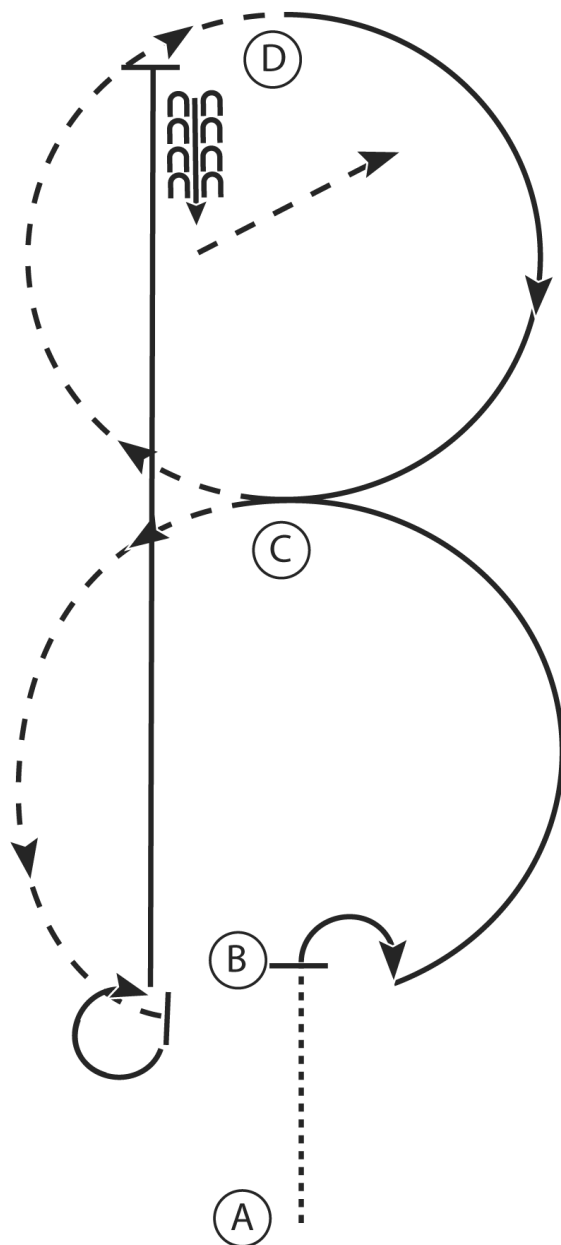

1. Walk A to B
2. At B stop and perform a 90 degree turn to the right
3. Canter on the left lead in a half circle to C
4. At C posting trot in a half circle to D on the correct diagonal
5. At D counter canter on the left lead in a half circle to C
6. At C posting trot half circle to just before B on the correct diagonal
7. Before B stop and perform a 270 degree turn to the right
8. Hand gallop to D
9. At D stop and back 4 steps
10. Sitting trot to exit

Walk
Trot	-----
Extended Trot	-----
Canter	—————
Leg Yield	
Lead Change	—/—
Back	←←←←
Marker	(B)
Sidepass	←←←←

[HSE/3-16]

Pattern Provided by:

Montana 4-H State Horse Committee

Montana State 4-H Horse Patterns

English Horsemanship (Level 6)

Show Date:

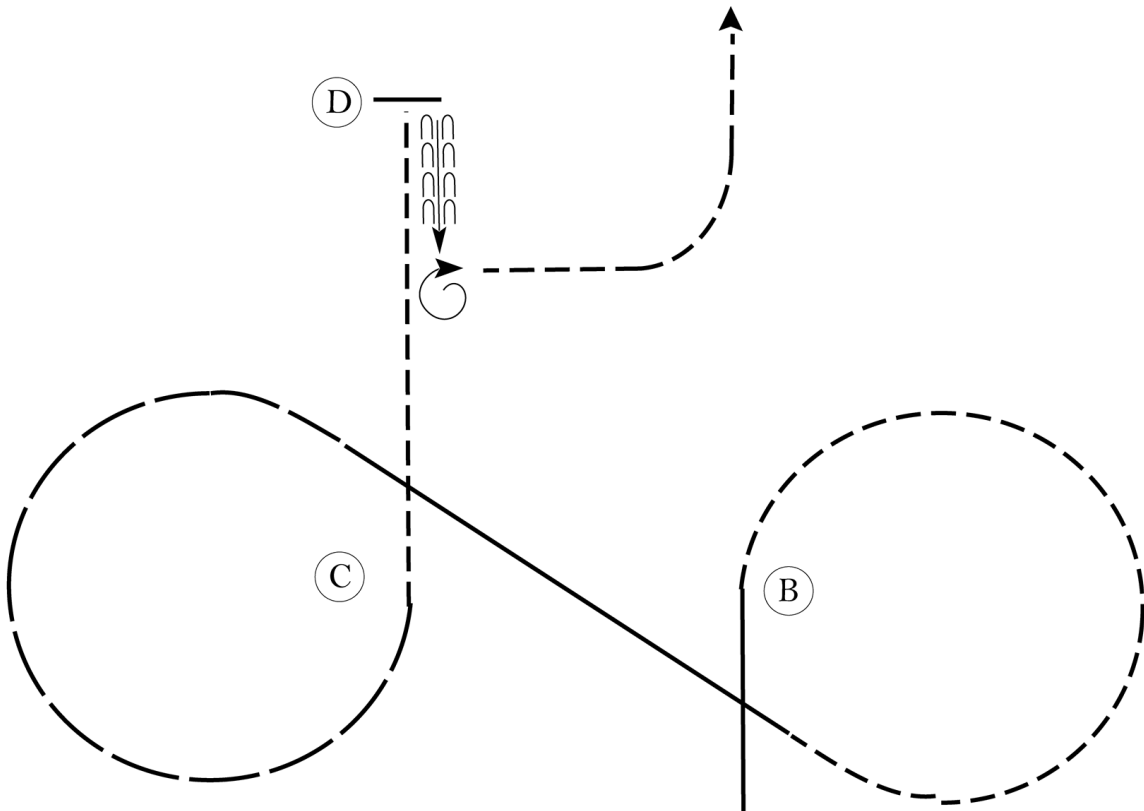

Be ready before A.

1. Walk to A.
2. Canter on the right lead to B.
3. Posting trot a circle to the right.
4. When even with B, canter on the left lead to C.
5. At C, hand gallop a circle to the left.
6. Trot on the right diagonal from C to D.
7. Stop at D and back approximately one horse length.
8. Perform a 1 1/4 turn to the right on the forehand.

Exit at a sitting trot.
Follow the instructions of your ring steward.

Walk	-----
Trot	- - - - -
Extended Trot	-----
Canter	—————
Leg Yield	
Lead Change	↙ ↘
Back	← ← ← ← ←
Marker	⊙
Sidepass	← — — — — →
Hand Gallop	-----

[HSE/3-41]

Pattern Provided by:

Montana 4-H State Horse Committee

www.HorseShowPatterns.com

www.HorseShowPatterns.com

Montana State 4-H Horse Patterns

English Horsemanship (Level 6)

Show Date:

www.HorseShowPatterns.com

www.HorseShowPatterns.com

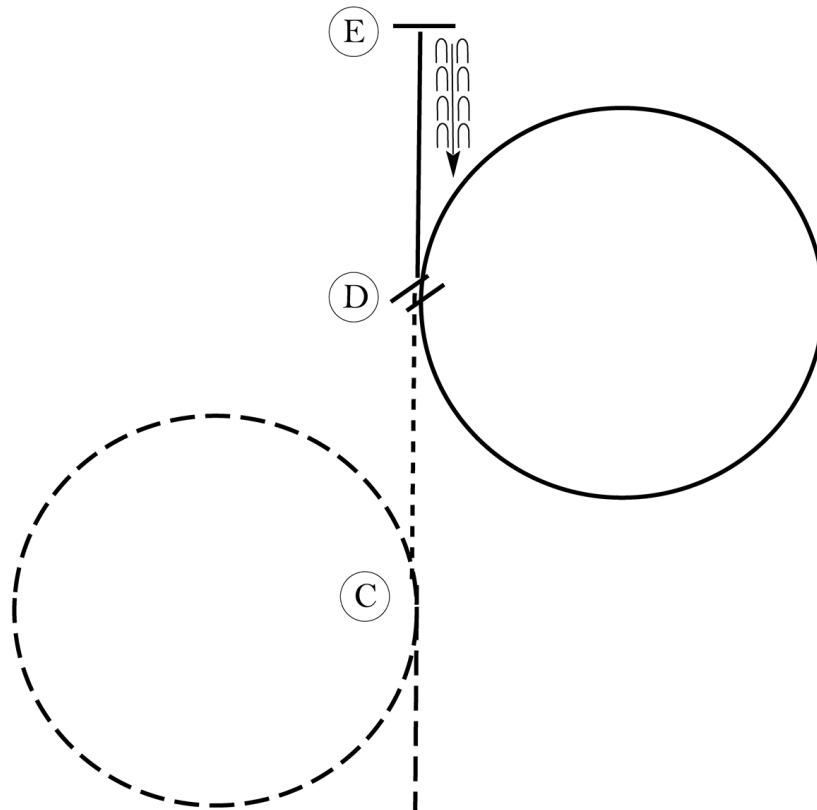

Be ready at A.

1. Sitting trot to B.
2. Drop your irons at B.
3. Posting trot on the left diagonal to C.
4. Change diagonals and circle to the left at C.
5. Walk from C to D while picking up your irons.
6. Canter a circle to the right at D.
7. Change leads at D and canter to E.
8. Stop at E and back approximately one horse length.

Exit at a trot.

Follow the instructions of your ring steward.

Walk	-----
Trot	- - - - -
Extended Trot	— — — — —
Canter	—————
Leg Yield	
Lead Change	↙ ↘
Back	← ← ← ← ←
Marker	⊙
Sidepass	← — — — — →
Hand Gallop	— — — — —

[HSE/3-39]

Pattern Provided by:

Montana 4-H State Horse Committee

EH-41 **Montana State 4-H Horse Patterns**

English Horsemanship (Level 6)

Show Date:

www.HorseShowPatterns.com

www.HorseShowPatterns.com

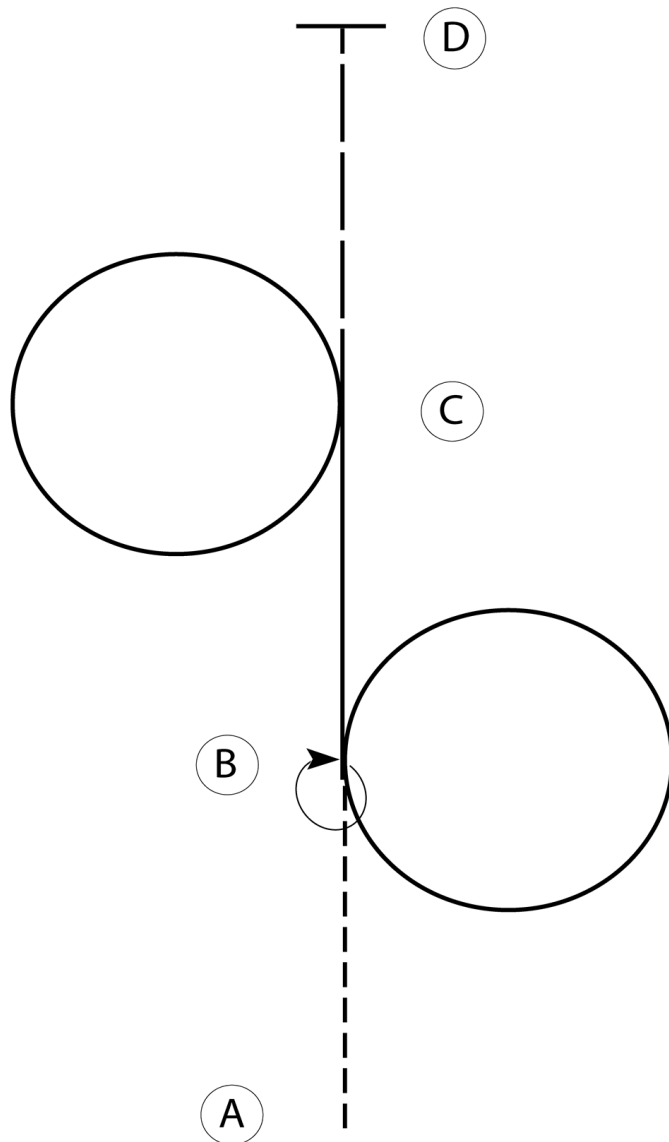

1. Posting trot on left diagonal from A to B
2. Canter on the right lead a circle to the right at B
3. At B stop and perform a 360 degree turn on the forehand to the right
4. Canter on the left lead to C. At C canter a circle to the left
5. Hang gallop to D
6. At D stop

Walk	-----
Trot	- - - - -
Extended Trot	-----
Canter	—————
Leg Yield	
Lead Change	↙ ↘
Back	← ← ← ← ←
Marker	⊙
Sidepass	← — — — →
Hand Gallop	—————

[HSE/3-32]

Pattern Provided by:

Montana 4-H State Horse Committee

Montana State 4-H Horse Patterns

English Horsemanship (Level 6)

Show Date:

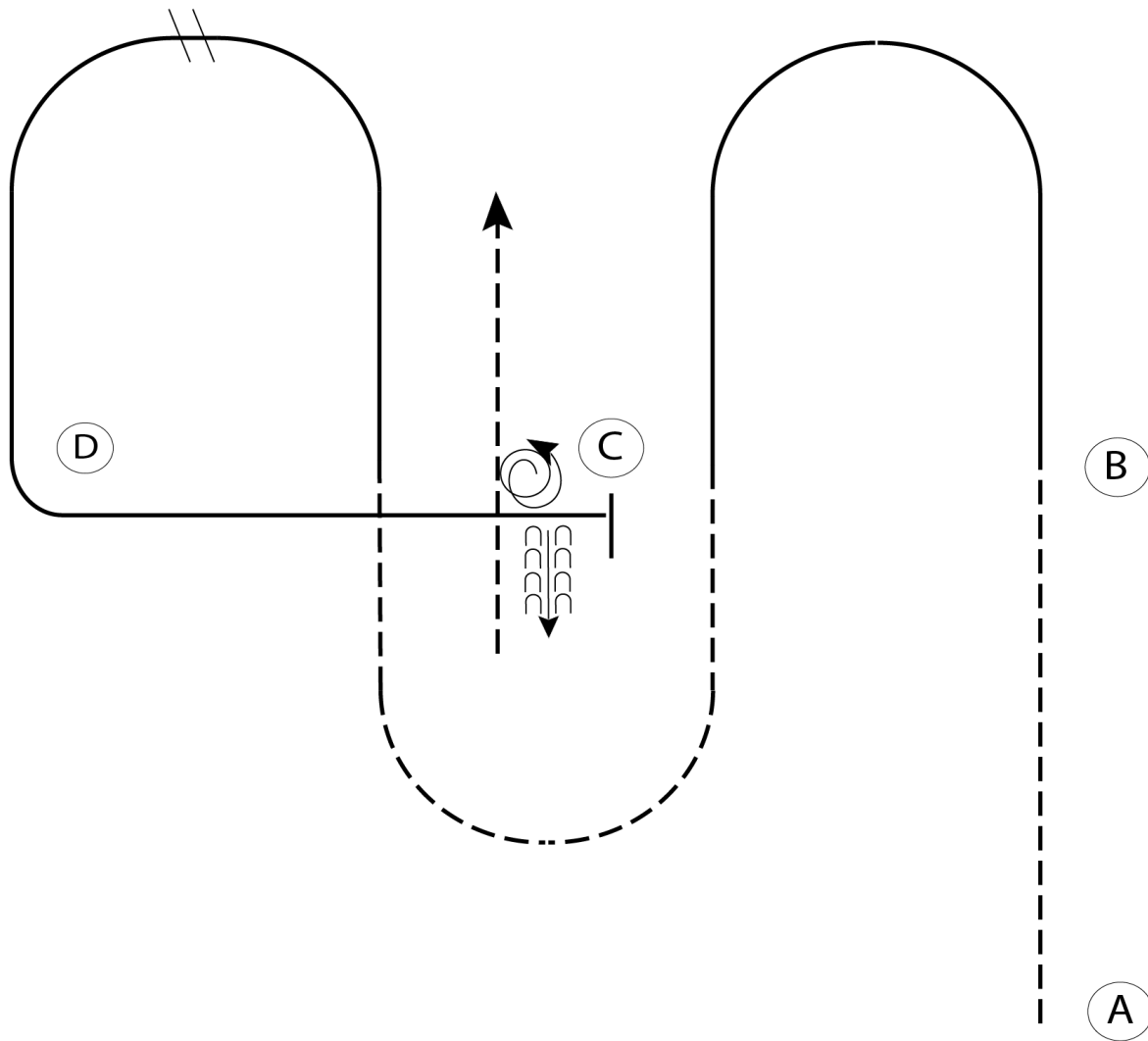

1. Posting trot from A to B on the correct diagonal
2. Canter on the left lead from B to C
3. Sitting trot in a half-circle from C until even with C
4. Canter left lead in a half circle. Halfway to D perform a flying lead change
5. Counter canter around D to C
6. At C stop and perform a 2 1/4 turn on the forehand to the left
7. Back two horse length and trot to the exit

Walk	-----
Trot	- - - - -
Extended Trot	-----
Canter	=====
Leg Yield	
Lead Change	////
Back	← c c c c
Marker	(B)
Sidepass	← - - - - - →
Hand Gallop	=====

[2015HSE/HSE3-30_2]

Pattern Provided by:

Montana 4-H State Horse Committee

www.HorseShowPatterns.com

www.HorseShowPatterns.com

Montana State 4-H Horse Patterns

English Horsemanship (Level 6)

Show Date:

www.HorseShowPatterns.com

www.HorseShowPatterns.com

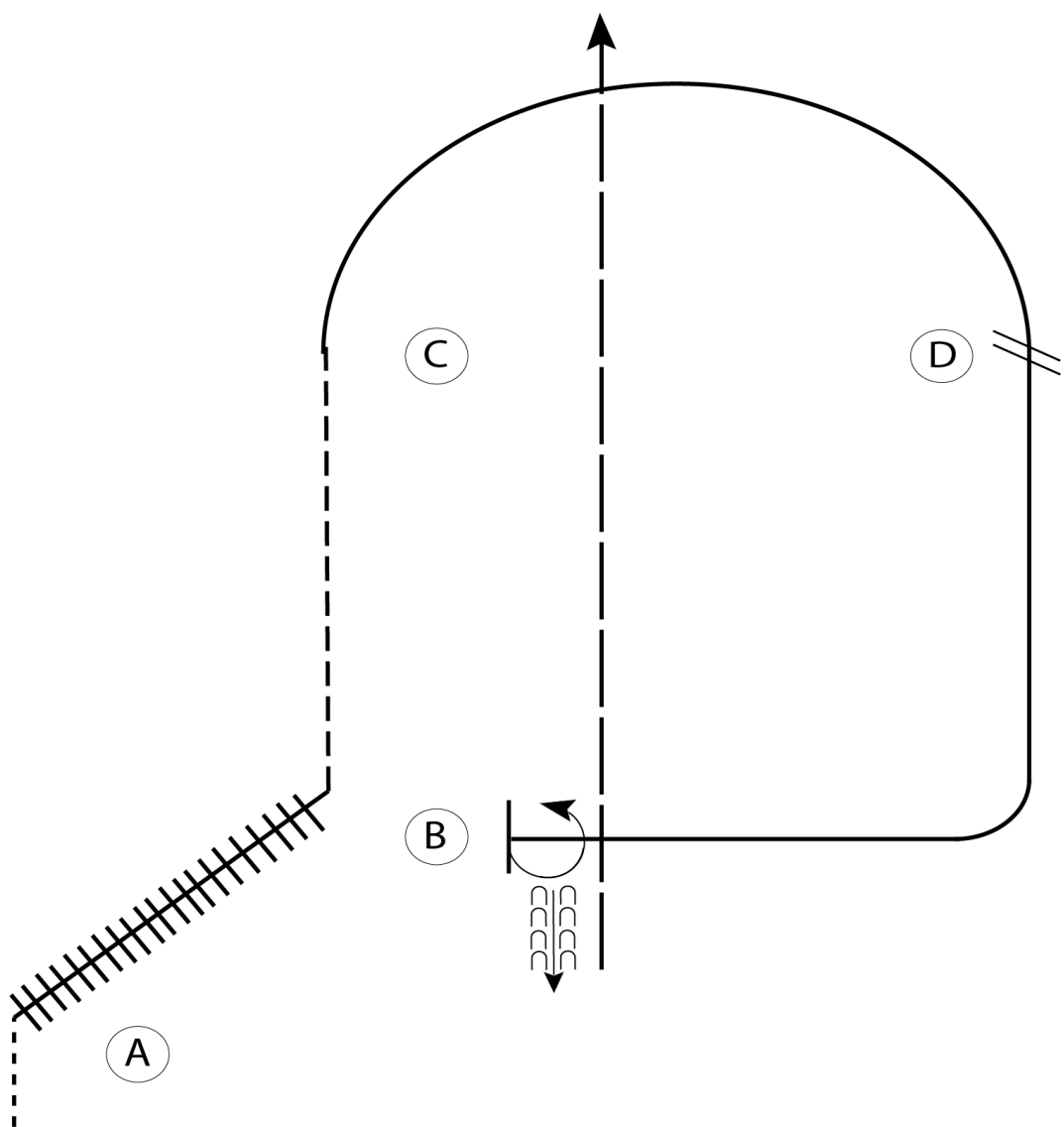

1. Begin before A. Walk to A
2. Leg yield to the right from A to B
3. Posting trot from B to C on the correct diagonal
4. Canter on the right lead from C to D
5. At D perform a flying lead change
6. Counter canter to B
7. At B stop and perform a 270 degree turn on the forehand to the left
8. Back one horse length and hand gallop in a two-point position to the exit

Walk
Trot	-----
Extended Trot	- - - - -
Canter	—————
Leg Yield	
Lead Change	///
Back	←←←←←
Marker	(B)
Sidepass	← - - - - ←
Hand Gallop	———

[2015HSE/HSE3-31]

Pattern Provided by:

Montana 4-H State Horse Committee

Montana State 4-H Horse Patterns

English Horsemanship (Level 6)

Show Date:

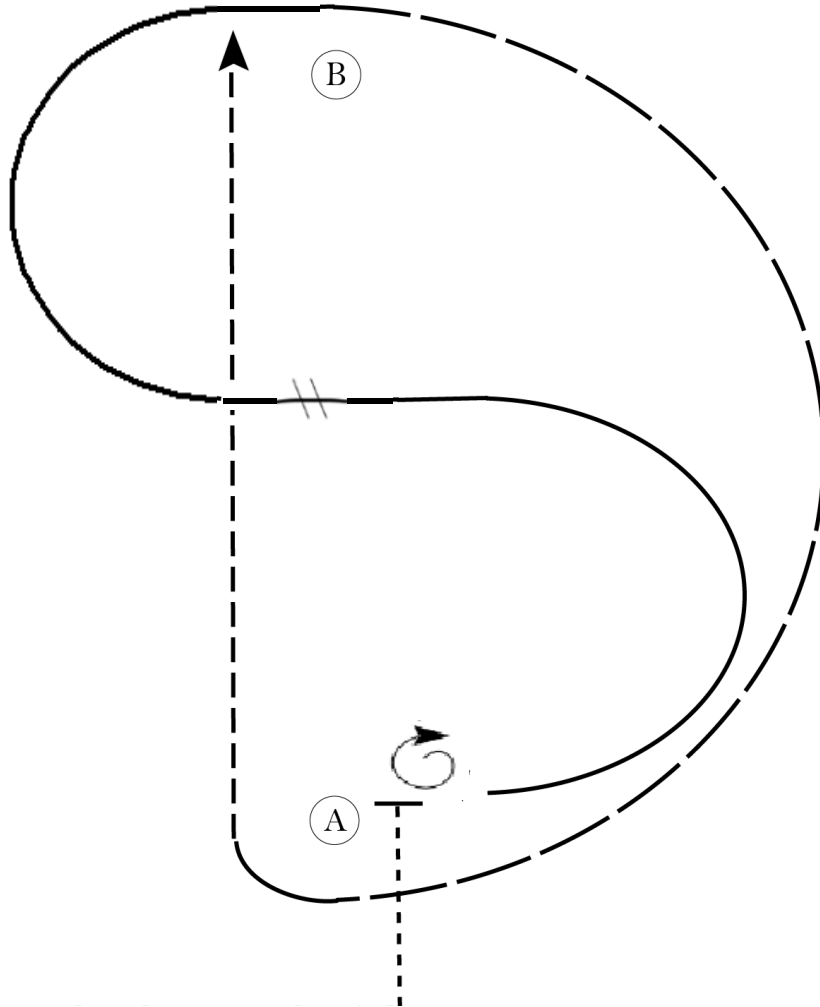

1. Walk to A.
2. Perform a 1 1/4 turn to the right.
3. Canter on the left lead in a half circle to center of the pattern.
4. Perform a flying lead change and lope in a half circle to B.
5. Hand gallop to and around A.
6. Trot on the correct diagonal to B.

Pattern is over once you pass B.

Follow the instructions of your ring steward.

Walk	-----
Trot	- - - - -
Extended Trot	-----
Canter	=====
Leg Yield	
Lead Change	↘ ↙
Back	← ← ← ← ←
Marker	⊙
Sidepass	← ← ← ← ←
Hand Gallop	-----

[HSE/3-67]

Pattern Provided by:

Montana 4-H State Horse Committee

www.HorseShowPatterns.com

www.HorseShowPatterns.com